

EAN: 4015474001695
static.hansa.com/55450900

Spare parts

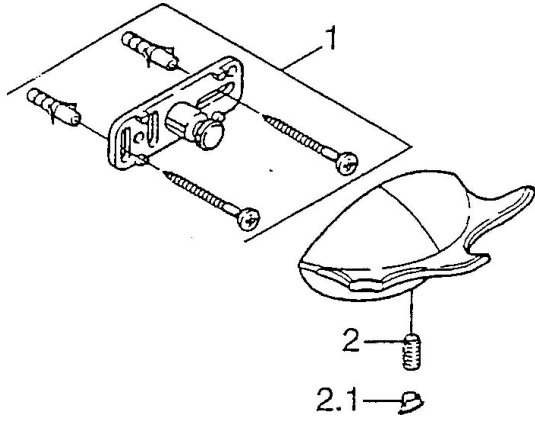

SP55450900

	Name		Code
1	Fixing set	Discontinued	59911816
2	Pin, M5x8, SW2.5	Discontinued	59911817
2.1	Plug Chrome	Discontinued	59911818