

EAN: 4015474112780  
[static.hansa.com/41129042](http://static.hansa.com/41129042)

## Spare parts

### SP41129042

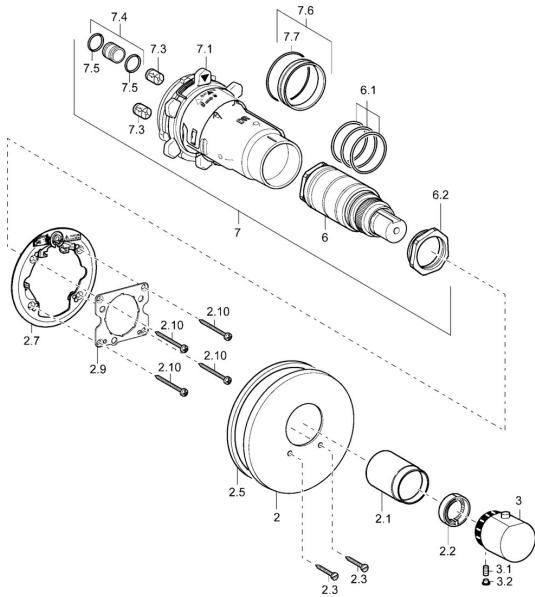

	Name	Code
2	Cover flange, d 56 mm	59913078
2	Cover flange, d 135 / d 56 mm Chrome <b>Discontinued</b>	59912882
2	Cover flange, d 170/56 mm Chrome <b>Discontinued</b>	59912928
2.1	Covering cap Chrome <b>Discontinued</b>	59912891
2.2	Retaining ring	59912892
2.3	Screw, M5x25 Chrome	59912881
2.5	Rubber gasket	59913045
2.7	Fixing part	59912888
2.9	Fixing plate	59913034
2.10	Screw, M4,5x80	59912890
3	Temperature control handle Chrome	59912126
3.1	Screw, M6x9,5	59901609
3.2	Cover plug Chrome	59911840
6	Thermostatic cartridge, H/C reversed	59911527
6	Thermostatic cartridge	59911525
6.1	O-ring, d 26x2	59911081
6.2	Eye screw, M34x1, AF36	59912988
7	Functional unit <b>Discontinued</b>	59912903
7.1	Blind nut	59912984
7.3	Non-return valve	59905714
7.4	Connection nipple, (2014-)	59913885
7.5	O-ring, d 14x2	59912982
7.6	Ring	59912989
7.7	O-ring, 50.52x1.78	59906841
N.I.	Raising kit, 20 mm	59912754
N.I.	Rebound pin	59912005