

EAN: 4057304004810
static.hansa.com/81802120

Spare parts

SP81802120

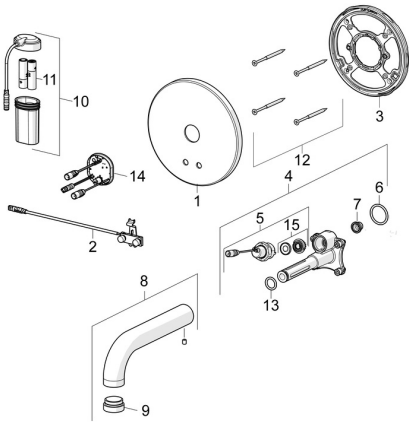

	Name	Code
01	Cover plate Chrome	59914543
02	Sensor	59914648
03	Fixing part Discontinued	59914545
04	Functional unit	59914546
05	Solenoid valve complete, 3 V	59914125
06	O-ring, 23.47x2.62	59914304
07	Litter filters	59914085
08	Spout, L=310 Chrome	59914549
09	Aerator, M24x1, -105	59914550
10	Battery casing	59914122
11	Battery, 1.5 V AA Lithium	59914136
12	Screw, M4.5x80	59912890
13	O-ring, d 13.1x2.62	59914551
14	Control unit, 3 V	59914552
15	Membrane for solenoid valve	1006500V
15	Membrane Discontinued	59914126