

EAN: 4015474002548
static.hansa.com/5554090092

Spare parts

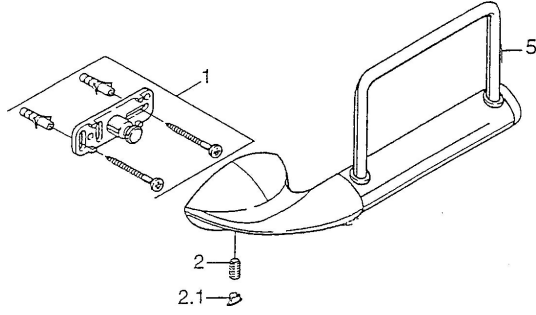

SP55540900

	Name	Code
1	Fixing set Discontinued	59911816
2	Pin, M5x8, SW2.5 Discontinued	59911817
2.1	Plug Chrome Discontinued	59911818