

EAN: 4015474001787
static.hansa.com/5546090092

Reserveonderdelen

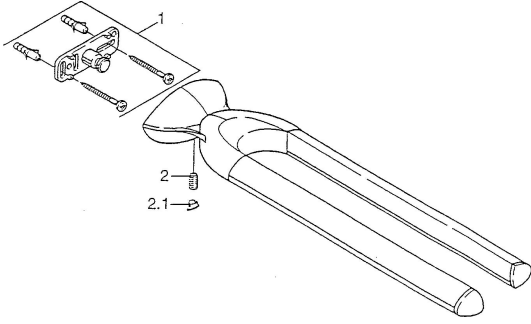

SP55460900

	Naam	Code
1	Bevestigingsset <input type="button" value="Stopgezet"/>	59911816
2	Pin, M5x8, SW2.5 <input type="button" value="Stopgezet"/>	59911817
2.1	Plug Chroom <input type="button" value="Stopgezet"/>	59911818