

EAN: 4015474001695
static.hansa.com/55450900

Reserveonderdelen

SP55450900

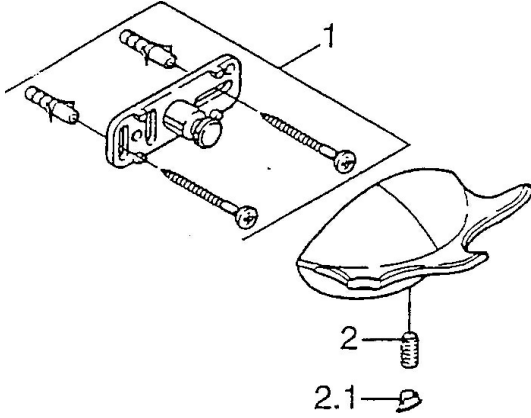

	Naam	Code
1	Bevestigingsset Stopgezet	59911816
2	Pin, M5x8, SW2.5 Stopgezet	59911817
2.1	Plug Chroom Stopgezet	59911818