

EAN: 4015474001411
static.hansa.com/55420900

Reserveonderdelen

SP55400900

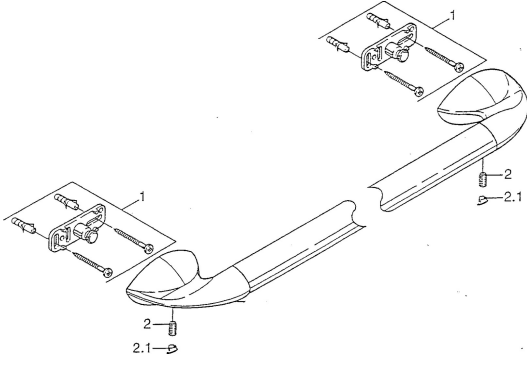

	Naam	Code
1	Bevestigingsset <input type="button" value="Stopgezet"/>	59911816
2	Pin, M5x8, SW2.5 <input type="button" value="Stopgezet"/>	59911817
2.1	Plug Chroom <input type="button" value="Stopgezet"/>	59911818