

EAN: 4015474001305
static.hansa.com/5541090092

Spare parts

SP55400900

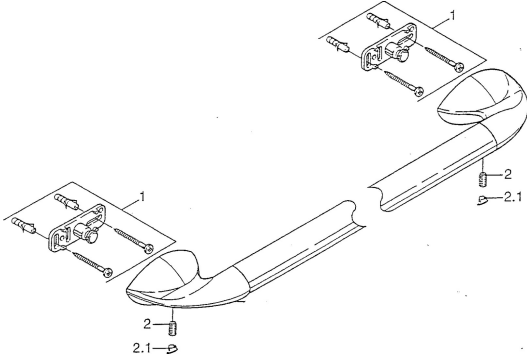

	Name	Code
1	Fixing set Discontinued	59911816
2	Pin, M5x8, SW2.5 Discontinued	59911817
2.1	Plug Chrome Discontinued	59911818