

EAN: 4015474023604
static.hansa.com/5133090074

Reserveonderdelen

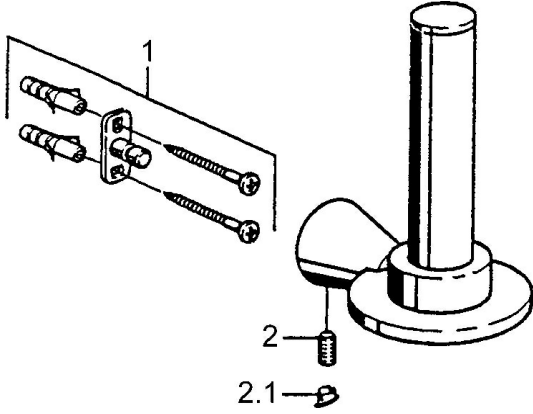

SP51330900

	Naam	Code
1	Bevestigingsset Stopgezet	59912081
2	Pin, M5x8 Stopgezet	59912082
2.1	Binnendeel temperatuurhendel Chrom Stopgezet	59912083