

EAN: 4015474023550
static.hansa.com/51310900

Reserveonderdelen

SP51310900

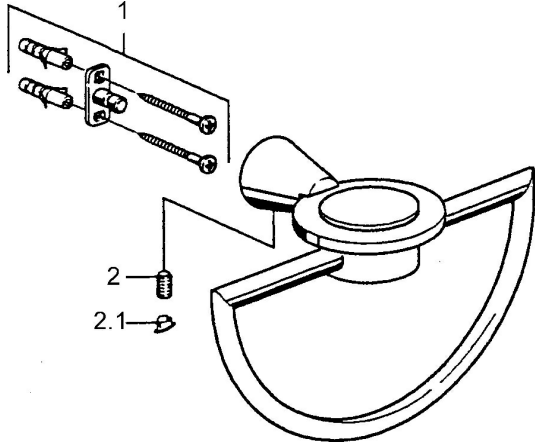

	Naam	Code
1	Bevestigingsset Stopgezet	59912081
2	Pin, M5x8 Stopgezet	59912082
2.1	Binnendeel temperatuurhendel Chroom Stopgezet	59912083