

EAN: 4015474114067
static.hansa.com/47093042

Reserveonderdelen

SP47093042

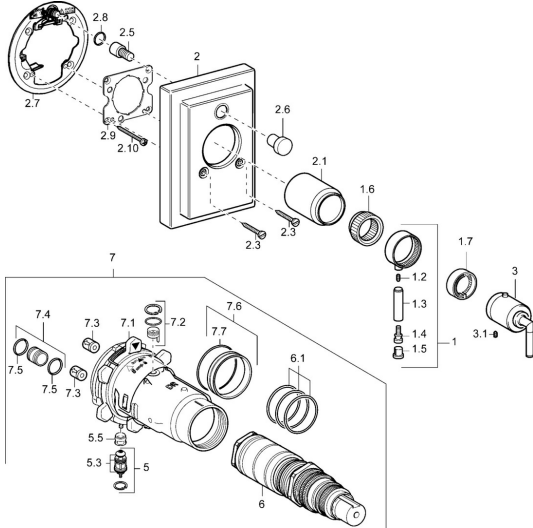

	Naam	Code
1	Hendel Stopgezet	59912603
1.6	Adapter	59912894
1.7	Temperature adjustment limiter Chroom	59912893
2	Afdekplaat Stopgezet	59913011
2.1	Kap Chroom Stopgezet	59912896
2.3	Schroef, M5x23, SW3 Chroom Stopgezet	59913012
2.5	Push button Stopgezet	59912940
2.6	Push button Chroom Stopgezet	59912884
2.7	Fixing part	59912889
2.8	O-ring, d 7.65x1.78	59902337
2.9	Fixing plate	59913034
2.10	Schroef, M4,5x80	59912890
3	Temperatuur hendel Stopgezet	59912605
3.1	Schroef, M6x16, SW2.5	59911727
5	Omsteller	59912985
5.3	Dichting Stopgezet	59912997
5.5	Zetel	59912229
6	Thermostaat/binnenwerk, 1/2" Varox	59912843
7	Functional unit Stopgezet	59912906
7	Functional unit, H/C reversed Stopgezet	59912979
7.1	Blind nut	59912984
7.2	Tegendrukklep	59912990
7.3	Terugslagklep	59905714
7.4	Aansluitnippel, (2014-)	59913885
7.5	O-ring, d 14x2	59912982
7.6	Ring	59912989
7.7	O-ring, 50.52x1.78	59906841
N.I.	Inbouwverlengstuk compleet, 20 mm	59912754
N.I.	Rebound pin	59912005