

EAN: 4057304013416  
[static.hansa.com/08806202](http://static.hansa.com/08806202)

## Spare parts

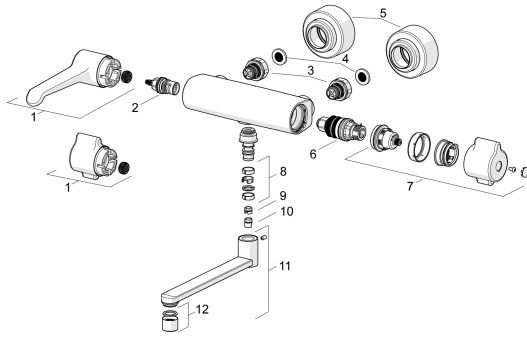

### SP08806202

	Name	Code
01	Flow control handle, L=150 mm Chrome	1004311V
01	Flow control handle Chrome	1006423V
02	Headpart, G1/2	59914207
03	Combiner	59914472
04	Filter sealing, G3/4	59911076
05	Cover flange Chrome	1006473V
06	Thermostatic cartridge, 3.4	59914114
07	Temperature control handle Chrome	1006058V
08	Sealing kit for spout Chrome	59914720
09	Limiter, 120°	59914728
10	Spout overturning stopper, 60° / 0°	59914264
11	Spout, L=200 Chrome	290017
12	Aerator, M22x1 STD PL HC A Laminar Chrome	1003610V