

EAN: 4015474658660
static.hansa.com/08385202

Spare parts

SP08382202

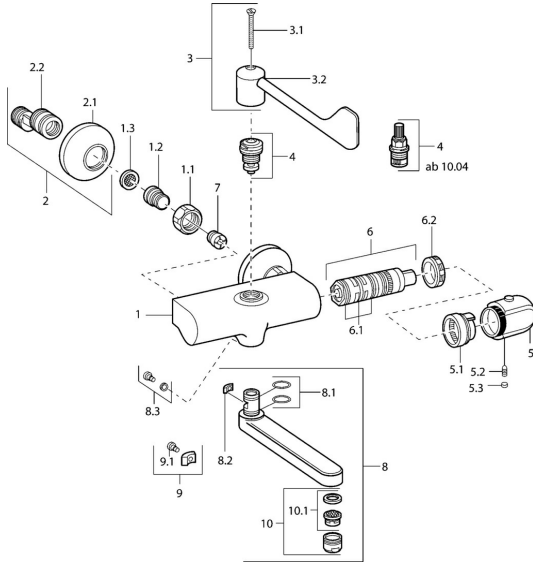

	Name	Code
1.1	Connection nut, G3/4, AF30	59902230
1.2	Nipple	59911075
1.3	Filter sealing, G3/4	59911076
2	Eccentric coupling with stop valves and cover plates, G1/2xG3/4 Chrome	59902034
2.1	Cover flange Chrome	59904796
3	Lever, (2004-) Chrome	59912715
3	Lever	59911377
3.1	Screw, M5x40 Discontinued	59911378
3.1	Screw, M4x18 (2004-) Chrome	59912716
4	Headpart, G1/2, 90°, (2004-)	59912626
4	Headpart, G1/2, DN 15	59901530
5	Temperature control handle, (2011-), desinfektion Chrome	59913869
5	Temperature control handle Chrome	59911830
5	Temperature control handle, 38° limited Chrome	59911726
5.1	Temperature adjustment limiter	59911660
5.2	Screw, M6x9.5	59901609
5.3	Cover plug Chrome	59911840
6	Thermostatic cartridge, H/C reversed	59911527
6	Thermostatic cartridge	59911525
6.1	O-ring, d 26x2	59911081
6.2	Tightening nut, M34x1, SW32	59911082
7	Non-return valve	59905714
8	Spout, L=170 Chrome	59911183
8	Spout, L=96 Chrome	59910419
8	Spout, L=235 Chrome	59910417
8	Spout, L=170 (2019-) Chrome	59914766
8	Spout, L=145 (2019-) Chrome	59914768
8	Spout, L=145 Chrome	59911380
8.1	O-ring, d 15x2.5	59910423
8.2	Limiter	59910422
8.3	Fixing screw, M6x12, AF2.5	59904804
8.4	Maintenance set	59912230
9	Limiter	59910421
9.1	Screw, M6x10, 2,5	59911435
10	Aerator, M24x1 A, low pressure Chrome	59902692
10	Aerator, M24x1 STD HC A Chrome	59902366
10.1	Aerator, M22/24 A	59902081
N.I.	Vacuum breaker, DN15	59911330
N.I.	Emptying valve	59912483
N.I.	Rebound pin	59912005