

EAN: 4015474637030
static.hansa.com/07869101

Spare parts

SP07869100

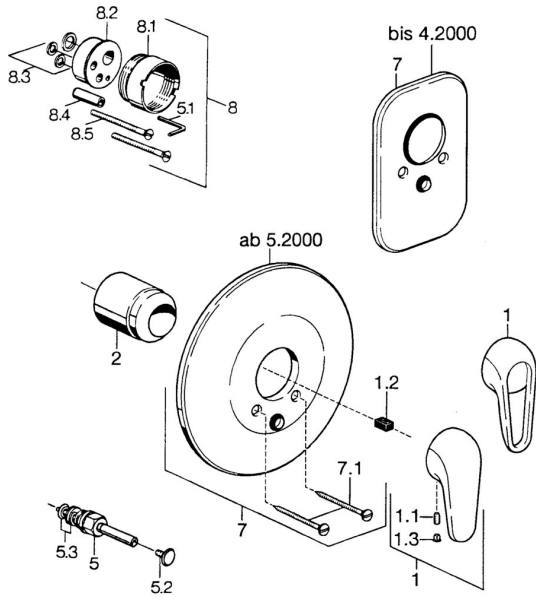

	Name	Code
2	Covering cap Chrome	59904820
5	Diverter White Discontinued	59910901
5	Diverter Chrome	59910900
5.2	Push button Chrome	59904828
5.3	Sealing kit	59904791
7	Cover flange White Discontinued	59911968
7	Cover plate, d 205 mm Chrome	59911967
7	Cover plate Chrome Discontinued	59911016
7.1	Screw, M5x65 White Discontinued	59906672
7.1	Screw, M5x65 Chrome	59904847
7.3	Flow limiting cap	59904846
8	Raising kit, 20 mm	59904983
8.3	Sealing kit	59904850