

EAN: 4015474531819
static.hansa.com/0319090094

Pièces de rechange

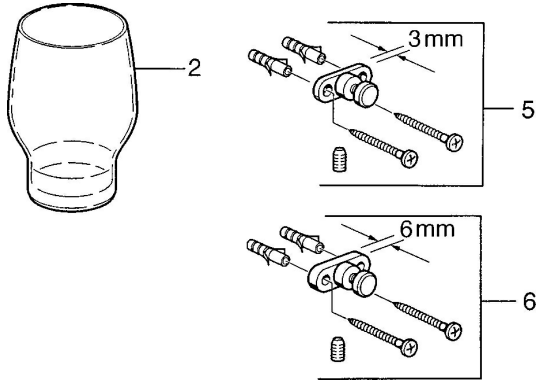

SP03190900

	Nom	Code
2	Verre Transparent Arrêté	59911627
5	Ensemble de fixation Arrêté	59911646