

EAN: 4057304016912
static.hansa.com/81812109

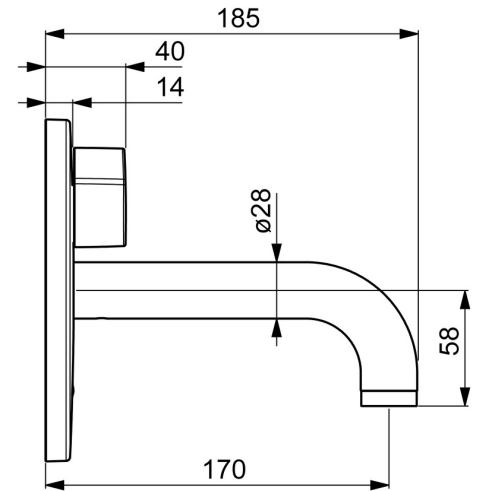

- Public & Semi-public, Health & Care, Industry
- Trim Kit, Touchless, Battery-operated, External transformer, Bluetooth®
- Concealed wall mounting
- Chrome
- Standard aerator, PCA® - constant flow rate regardless of pressure variations
- Temperature control handle
- Mixing valve for manual temperature control, Non-return valve(s), Litter filter(s)
- Autofocus infrared sensor, Solenoid valve, External control unit, Light indicated function(s), Low battery indicator
- Software settings adjustable via App
- Round rosette
- Without transformer

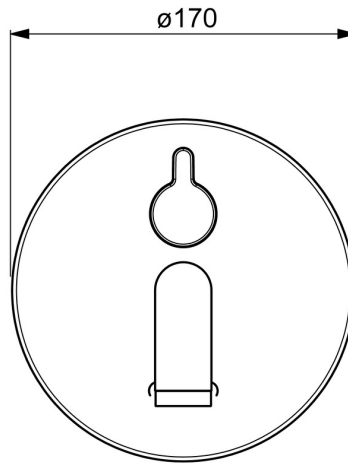
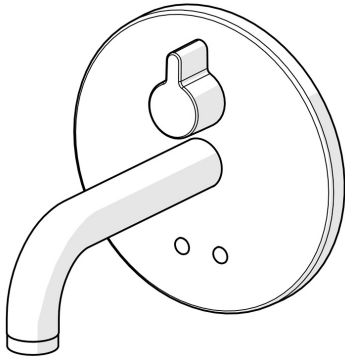

Technical data

Flow properties

Flow-rate at 3 bar (with flow controller) **4.8 l/min**

Technical properties

Hot water supply **max. +70°C**
 Working pressure **1-10 bar**
 Projection **170 mm**
 Backflow prevention (EN1717) **AA**
 Material **Brass**

Software settings

Afterflow period **3 s (1-20 s)**
 Automatic flush **off (off/1-120 h)**
 Automatic flush period **30 s (1-1800 s)**
 Max. flow period **2 min (1 - 1800 s)**

Electronic properties

Electrical Connection **12 V**
 Battery **AA 1.5 V Lithium x 2**
 Bluetooth version **5.x (D060576)**

Regulations

EU Directives **C € Radio Equipment Directive 2014/53/EU , Low Voltage Directive 2014/35/EU , EMC Directive 2014/30/EU , RoHS Directive 2011/65/EU**
 EN standard **EN 15091, ETSI EN 301 489-1 V1.9.2 , ETSI EN 300 328 v2.2.2 , EN 61000-6-1:2007 , EN 61000-6-3:2007+A1:2011+AC:2012 , EN 60335-1:2012+A11+A13+A1+A14+A2+A15:2021, Part 19.11.4**
 Noise class **I (ISO 3822)**
 Protection class **IP 55**

Approvals and Declarations

ABP **PA-IX 10143/IO**
 UN38.3 **UN38-3 Energizer L91**
 Declaration of conformity **RED**

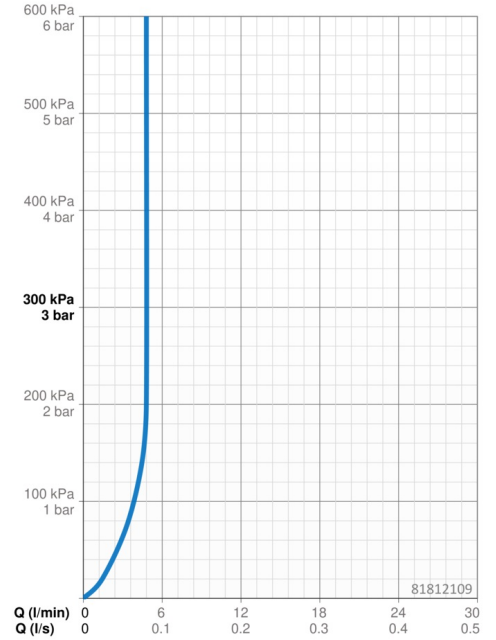

Spare parts

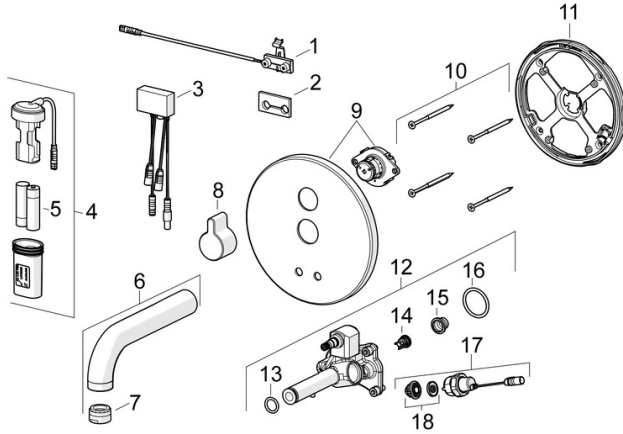

SP81812119

	Name	Code
01	Sensor, 245 mm	1010227V
02	Gasket	1010472V
03	Control unit, 3/12 V Bluetooth	1009970V
04	Battery casing	59914122
05	Battery, 1.5 V AA Lithium	59914136
06	Spout, L=170	59914547
06	Spout, L=245	59914548
06	Spout, L=310	59914549
07	Aerator, M24x1, -105	59914550
08	Handle	59914322
09	Cover plate, d 170 mm	59914553
10	Screw, M4,5x80	59912890
11	Fixing part Discontinued	59914554
12	Functional unit	59914555
13	O-ring, d 13.1x2.62	59914551
14	Non-return valve, DN8	59914030
15	Litter filters	59914085
16	O-ring, 23.47x2.62	59914304
17	Solenoid valve complete, 3 V	59914125
18	Membrane for solenoid valve	1006500V
18	Membrane Discontinued	59914126