

EAN: 4057304008542
static.hansa.com/80812121

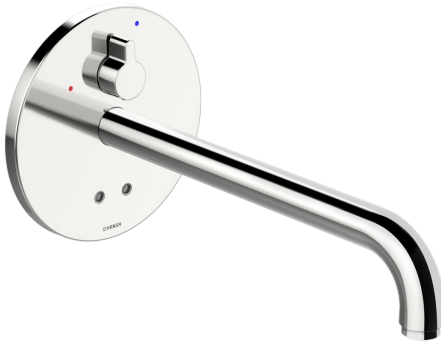

- Public & Semi-public
- Touchless, External transformer, Trim Kit
- Concealed wall mounting
- Chrome
- PCA® - constant flow rate regardless of pressure variations, Standard aerator
- Temperature control handle
- Mixing valve for manual temperature control, Litter filter(s), Non-return valve(s)
- Autofocus infrared sensor, Solenoid valve, External control unit, Light indicated function(s)
- Software settings adjustable via magnetic key, Manual, ceramic, pressure independent diverter with volume control and stop function for two outlets
- Round rosette, BLUECLICK for an easy, screwless trim plate installation
- Without transformer

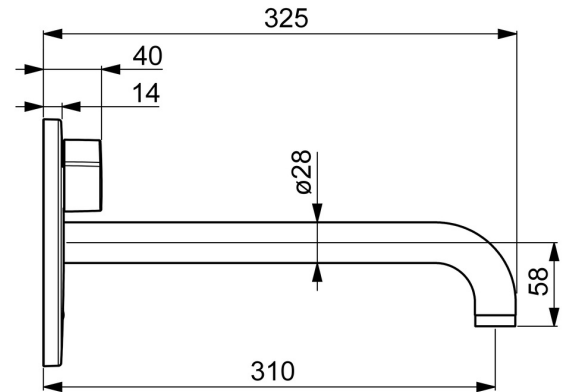
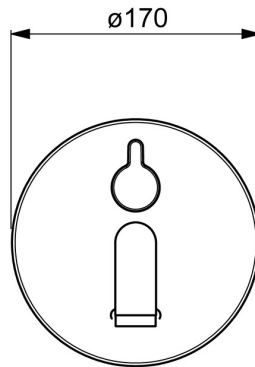
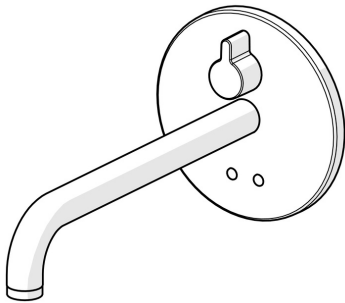

Technical data

Flow properties

Flow-rate at 3 bar (with flow controller) **4.8 l/min**

Technical properties

Hot water supply **max. +70°C**
 Working pressure **1-10 bar**
 Projection **310 mm**
 Backflow prevention (EN1717) **AA**
 Material **Brass**

Software settings

Afterflow period **3 s (1/2/3/4/5/6/7/8/9/10 s)**
 Automatic flush **off (off/6/12/18/24/30/36/48/60/72 h)**
 Automatic flush period **30 s (30/60/90/120/180/240/300/360/480/600 s)**
 Max. flow period **60 s (10/30/60/90/120/150/180/210/240/300 s)**

Electronic properties

Electrical Connection **12 VDC**

Regulations

EU Directives **C E Low Voltage Directive 2014/35/EU, EMC Directive 2014/30/EU, RoHS Directive 2011/65/EU**
 EN standard **EN 15091, ETSI EN 301 489-1 V1.9.2, ETSI EN 300 328 v2.2.2, EN 61000-6-1:2007, EN 61000-6-3:2007+A1:2011+AC:2012, EN 60335-1:2012+A11+A13+A14+A2+A15:2021, Part 19.11.4**
 Noise class **I (ISO 3822)**
 Protection class **IP 55**

Approvals and Declarations

ABP **PA-IX 10143/IO**
 Declaration of conformity **LVD**

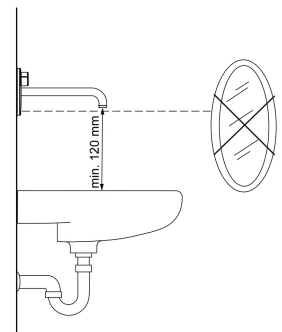
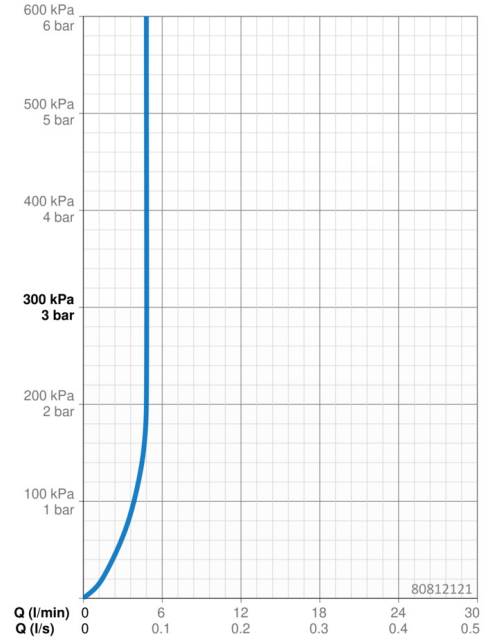

Spare parts

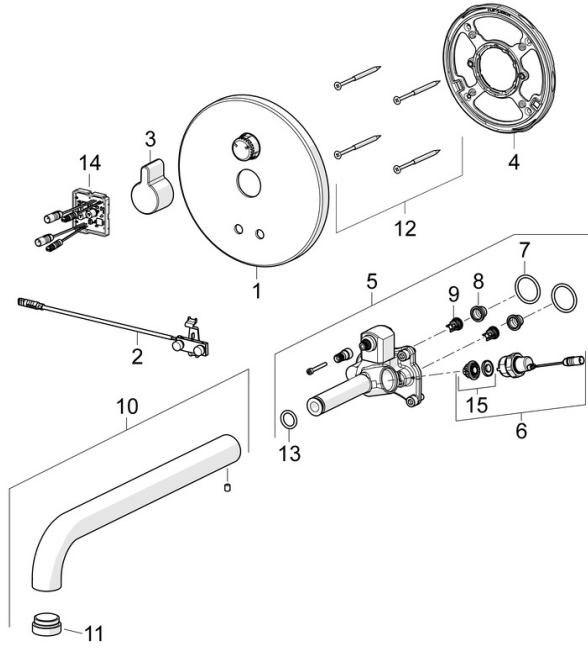

SP80812121

	Name	Code
01	Cover plate, d 170 mm	59914553
02	Sensor	59914648
03	Handle	59914322
04	Fixing part Discontinued	59914554
05	Functional unit	59914555
06	Solenoid valve complete, 3 V	59914125
07	O-ring, 23.47x2.62	59914304
08	Litter filters	59914085
09	Non-return valve, DN8	59914030
10	Spout, L=310	59914549
11	Aerator, M24x1, -105	59914550
12	Screw, M4,5x80	59912890
13	O-ring, d 13.1x2.62	59914551
14	Control unit, 12 V	59914560
15	Membrane for solenoid valve	1006500V
	Membrane Discontinued	59914126