

EAN: 4057304014802
static.hansa.com/57649583

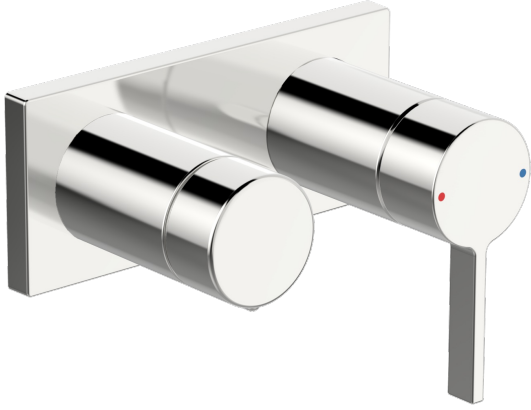

- Bathtub & Shower
- Single-lever, Trim Kit
- Concealed wall mounting
- Chrome
- Hot/Cold symbols, Single operating lever/handle
- Turn operated diverter
- Rosette plate frame, Square rosette, Sleeve, BLUECLICK for an easy, screwless trim plate installation
- with 2-way-diverter

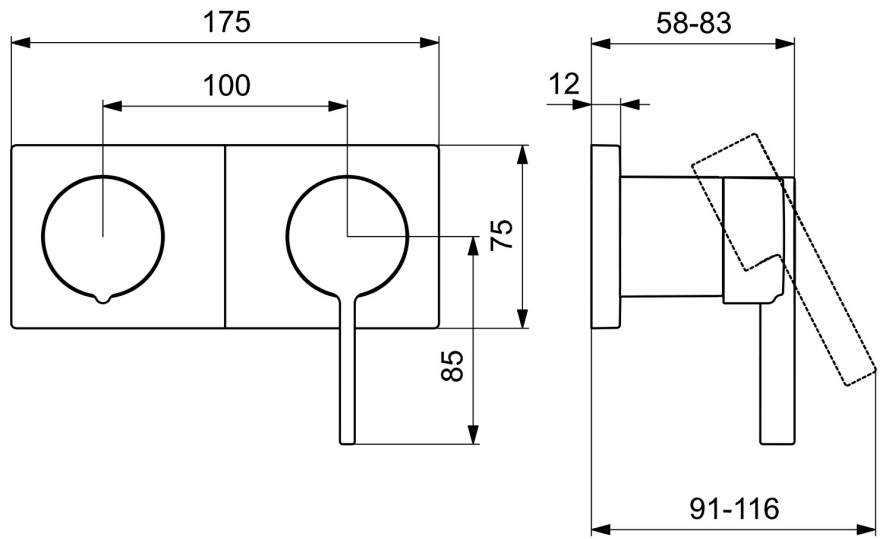
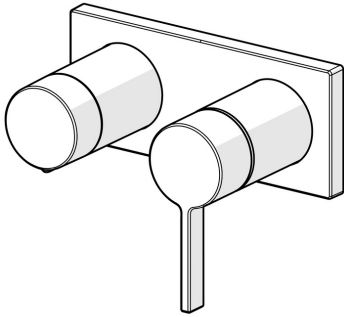

Technical data

Flow properties

Flow-rate at 3 bar	16.8 / 12.0 l/min
Pressure loss with flow (0.2 l/s)	3 bar

Technical properties

Hot water supply	max. +80°C
Working pressure	0.5-10 bar
Material	Brass

Regulations

EN standard	EN 817
Noise class	II (ISO 3822)

Approvals and Declarations

Declaration of conformity	DoC
EPD	S-P-07752

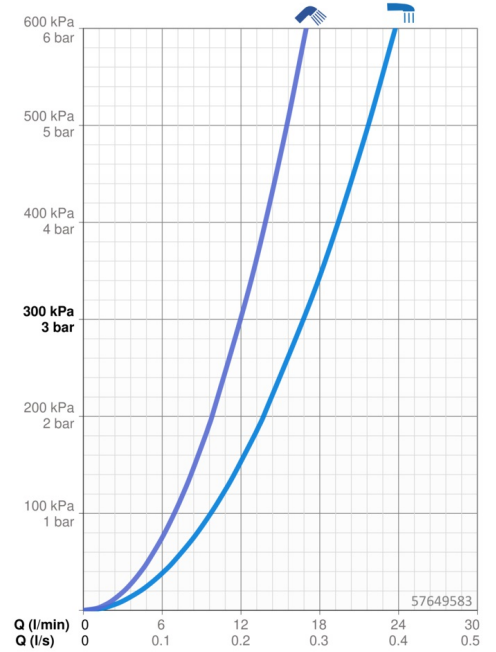

Spare parts

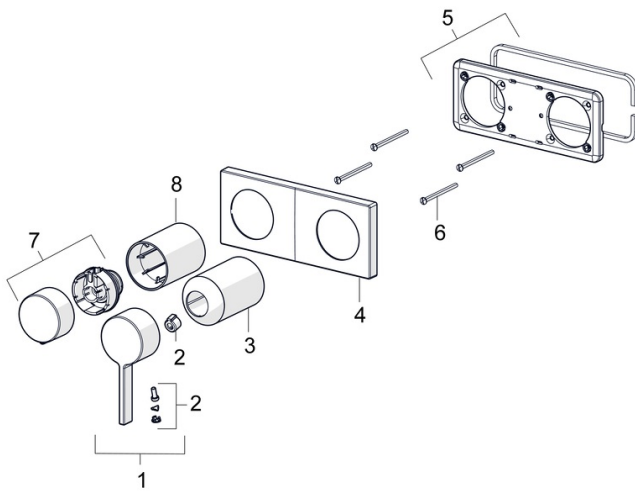

SP57649583

	Name	Code
01	Lever	1003930V
02	Symbol plug	59914573
03	Cover sleeve	59914572
04	Cover plate Discontinued	59914702
05	Cover plate holder	59913697
06	Screw, M4x55	59913698
07	Flow control handle Discontinued	59914703
08	Cover sleeve	59914671