

EAN: 4057304018527
static.hansa.com/571622790005

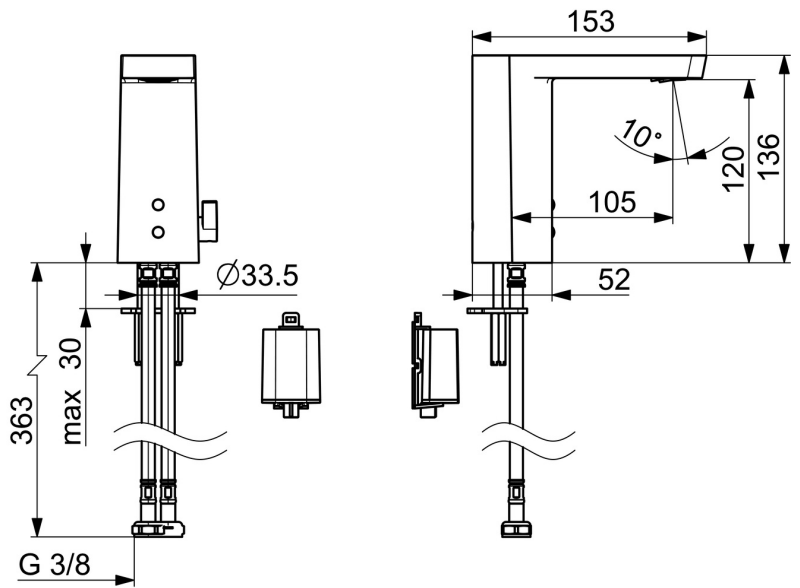

Touchless washbasin faucet, designed with the latest technology for a smart and seamless experience. This deck-mounted faucet features a touchless operation and Bluetooth® connectivity, allowing for easy control via the app. The temperature control handle offers precise water temperature adjustments, while touchless faucets are proven to reduce water consumption by up to 50%, making it an eco-friendly choice. The inner body is made of corrosion resistant brass, ensuring long-lasting performance. With software settings adjustable via app and convertible for cold or premixed-water supply, this faucet brings sustainability and is perfect for both public and semi-public washrooms. Choose flexibly between three operating modes, Adjust general faucet settings, Schedule automatic cleaning and flush mode. Upgrade to the Stela line for a perfect balance of design and technology.

- Industry, ECO Building, Housing
- Touchless, Battery-operated, Bluetooth®
- Deck mounted
- Chrome
- Fixed spout, Casted construction
- PCA® - constant flow rate regardless of pressure variations
- Temperature control handle
- Adjustable hot water stop (included, retrofittable)
- Mixing valve for manual temperature control, Non-return valve(s)
- Autofocus infrared sensor, Solenoid valve, Low battery indicator
- Flexible inlet pipes
- Inner body made of DZR brass, Software settings adjustable via App, Convertible for cold or premixed-water supply
- Without pop-up waste

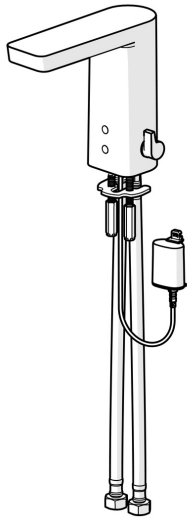

Technical data

Flow properties

Flow-rate at 3 bar (with flow controller) **4.2 l/min**

Technical properties

DN-size (nominal dimension) **DN15**
 Hot water supply **max. +70°C**
 Working pressure **1-10 bar**
 Connection size **G3/8**
 Projection **105 mm**
 Backflow prevention (EN1717) **AA**
 Material **Brass**

Software settings

Afterflow period	3 s (1-20 s)
Automatic flush	off (off/1-120 h)
Automatic flush period	30 s (1-1800 s)
Max. flow period	2 min (1 - 1800 s)

Electronic properties

Battery	Lithium 2CR5 6 V
Bluetooth version	4.x (D034445)

Regulations

EU Directives	C € Radio Equipment Directive 2014/53/EU , Low Voltage Directive 2014/35/EU , EMC Directive 2014/30/EU , RoHS Directive 2011/65/EU
EN standard	EN 15091, ETSI EN 301 489-1 V1.9.2 , ETSI EN 300 328 v2.2.2 , EN 61000-6-1:2007 , EN 61000-6-3:2007+A1:2011+AC:2012 , EN 60335-1:2012+A11+A13+A1+A14+A2+A15:2021, Part 19.11.4
Noise class	I (ISO 3822) Oras lab.
Protection class	IP 55

Approvals and Declarations

DVGW	CW-6514CR0161
ABP	P-IX 38184/10
UN38.3	UN38-3 Maxell 2CR5
Declaration of conformity	RED
EPD	S-P-06394

Sustainability

EPD module A1 (kg CO2 eq.)	10,02
EPD module A2 (kg CO2 eq.)	0,46
EPD module A3 (kg CO2 eq.)	0,54
EPD module A1-A3 (kg CO2 eq.)	11,02
EPD module A4 (kg CO2 eq.)	0,40
EPD module B7 (kg CO2 eq.)	301,00
EPD module C2 (kg CO2 eq.)	0,02
EPD module C3 (kg CO2 eq.)	0,02
EPD module C4 (kg CO2 eq.)	0,31
EPD module D (kg CO2 eq.)	-8,04

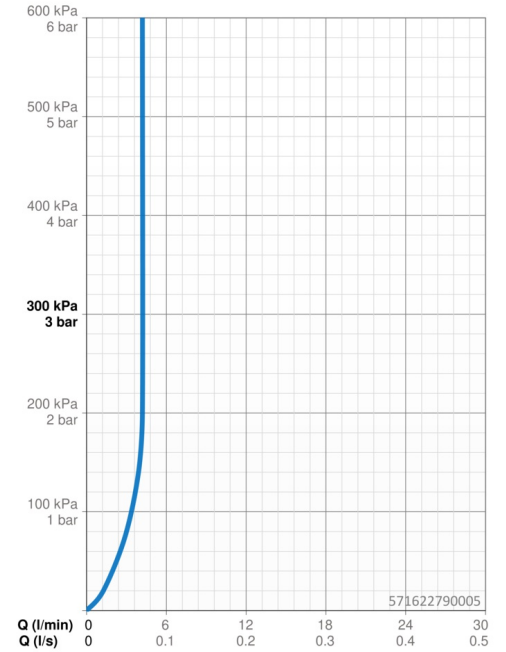

Spare parts

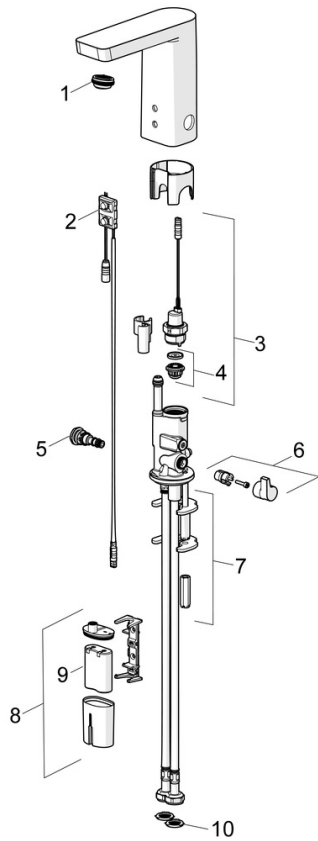

SP57162279

	Name	Code
01	Aerator, M24x1 HC SSR-STD	59914015
02	Sensor, 6/9/12 V, Bluetooth	59914567
03	Solenoid valve, 6 V	59914091
04	Membrane for solenoid valve	1006500V
04	Membrane support ring Discontinued	59914090
05	Temperature regulator	59914089
06	Temperature control handle	59914189
07	Fixing plates with nuts	59914132
08	Battery casing, 2CR5 6 V	59914088
09	Battery, 2CR5 6 V	59911670
10	Filter sealing	1007900V
N.I.	Limiter	59914106