

EAN: 4015474001107
static.hansa.com/55400900

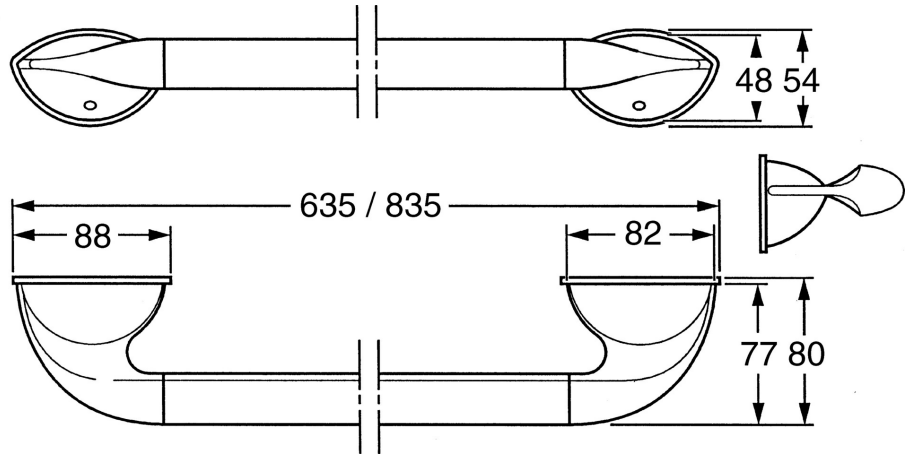

- Salle de bain
- Equipement auxiliaire
- Montage mural
- Chrome



Caractéristiques techniques

Pièces de rechange

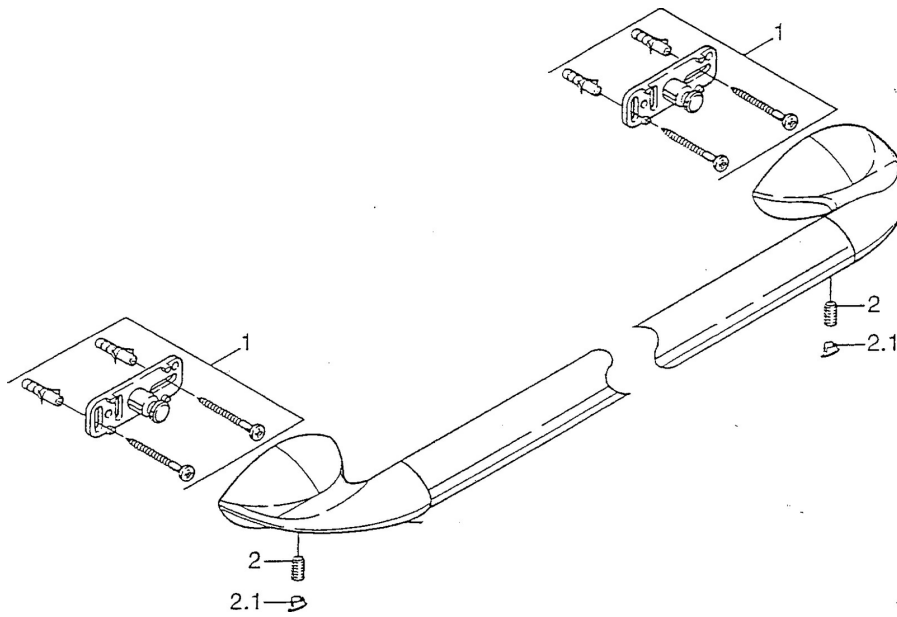

SP55400900

	Nom	Code
1	Ensemble de fixation Arrêté	59911816
2	Goupille, M5x8, SW2.5 Arrêté	59911817
2.1	Bouchon cache trou Arrêté	59911818