

EAN: 4015474257160
static.hansa.com/52381177

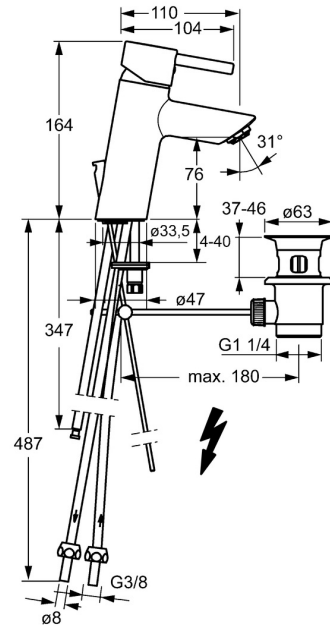

- Washbasin
- Single-lever, Low pressure
- Deck mounted
- Chrome
- Fixed spout
- Laminar stream, Standard aerator
- Hot/Cold symbols, Pin shape, Single operating lever/handle
- Pop-up waste with draw-rod
- Limitation option for maximum temperature and flow-rate, Adjustable hot water stop (included, retrofittable)
- \varnothing 35 mm ceramic cartridge for flow and temperature control
- Copper inlet pipes
- Inner body made of DZR brass, Rapid installation system

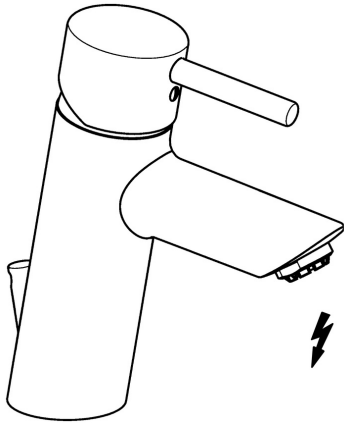

Technical data

Technical properties

DN-size (nominal dimension)	DN15
Hot water supply	max. +80°C
Working pressure	0.5-5 bar
Connection size	\varnothing 8 mm
Projection	110 mm
Backflow prevention (EN1717)	AA
Material	Brass

Regulations

EN standard	EN 817
-------------	---------------

Approvals and Declarations

Declaration of conformity	DoC
---------------------------	------------

Spare parts

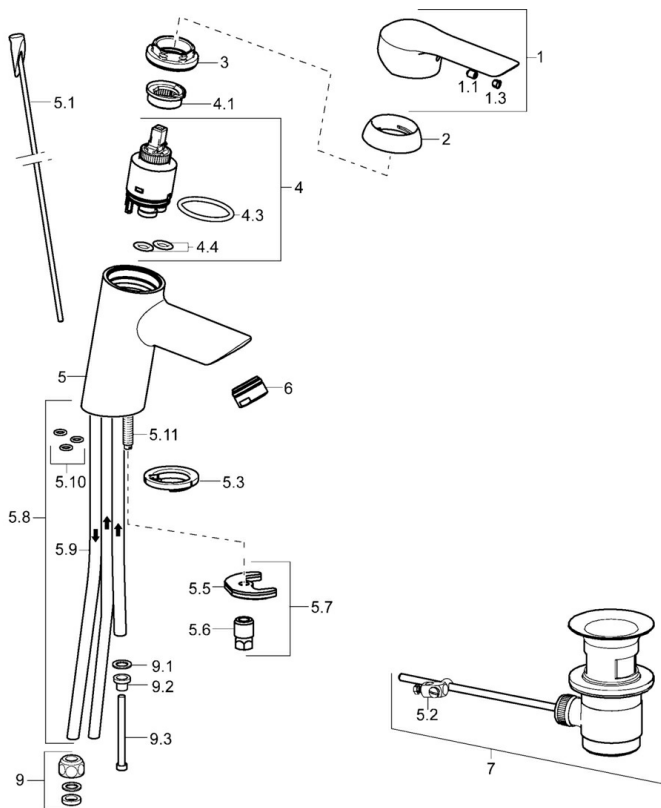

SP52461173

	Name	Code
1	Lever	59914629
1.1	Screw, M5x8, SW2.5	59904755
1.3	Symbol plug Grey	59912112
2	Covering cap, 33x3 mm	59912504
3	Tightening nut, M40x1	1003409V
4	Cartridge, 3.5 Eco	59912324
4	Cartridge, 3.5 Classic	59913075
4.1	Temperature adjustment limiter	59912325
4.3	O-ring, d 28.24x2.62 Discontinued	59912590
4.4	O-ring, d 10.10x1.60 Discontinued	59905072
5.1	Pop-up operating rod	59913587
5.2	Swivel joint	59904624
5.3	Bottom seal	59914591
5.5	Fixing plate	59904765
5.6	Screw, M8x1, SW13	59904766
5.7	Fixing set	59912113
5.8	Pipe Discontinued	59913398
5.9	Pipe, M8x1, L=560	59912806
5.10	O-ring, 6x1.4	59913266
5.11	Fixing screw, M8x1, L=140	59912474
6	Aerator, M24x1 A, low pressure	59902692
7	Pop-up waste	59904620
7	Pop-up waste, (2019-)	59914764
9	Fitting nut	59904969
9.1	Sealing kit, 14.9x8.5x1	59902352
9.2	Sealing kit, 10x8	59902272
9.3	Hose	59902151
N.I.	Key, SW30/34	59912108