

EAN: 4015474113268
static.hansa.com/46629041

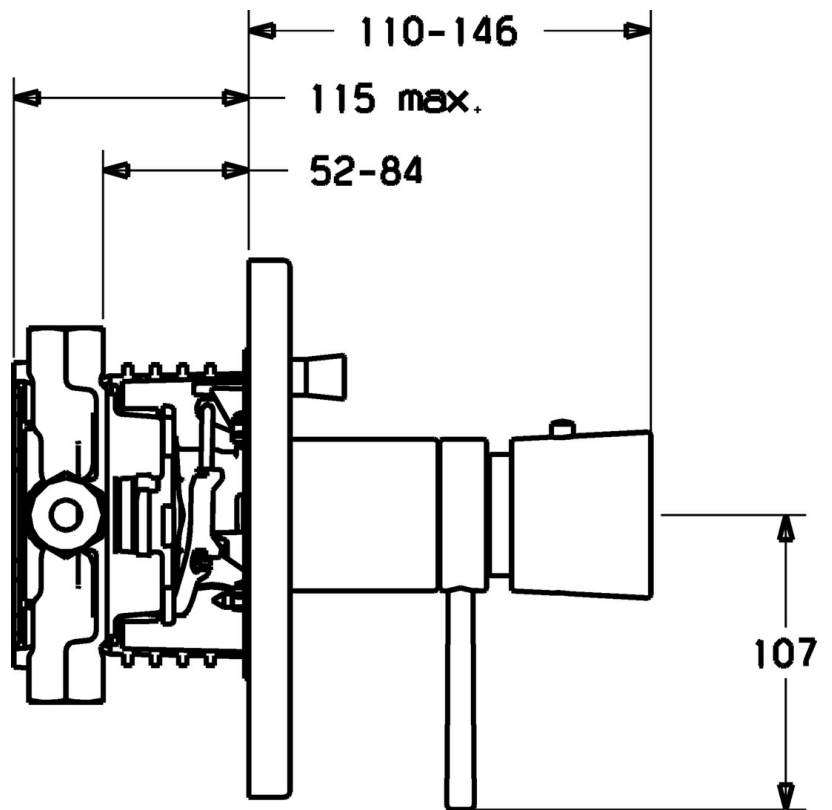

- Bathtub & Shower
- Thermostatic, Trim Kit
- Concealed wall mounting
- Chrome
- Temperature control handle, Flow control handle
- Thermostatic cartridge for automatic temperature control, Non-return valve(s)
- Round rosette



Technical data

Technical properties

Hot water supply	max. +80°C
Working pressure	1-10 bar
Backflow prevention (EN1717)	EB

Regulations

EN standard	EN 1111
-------------	----------------

Spare parts

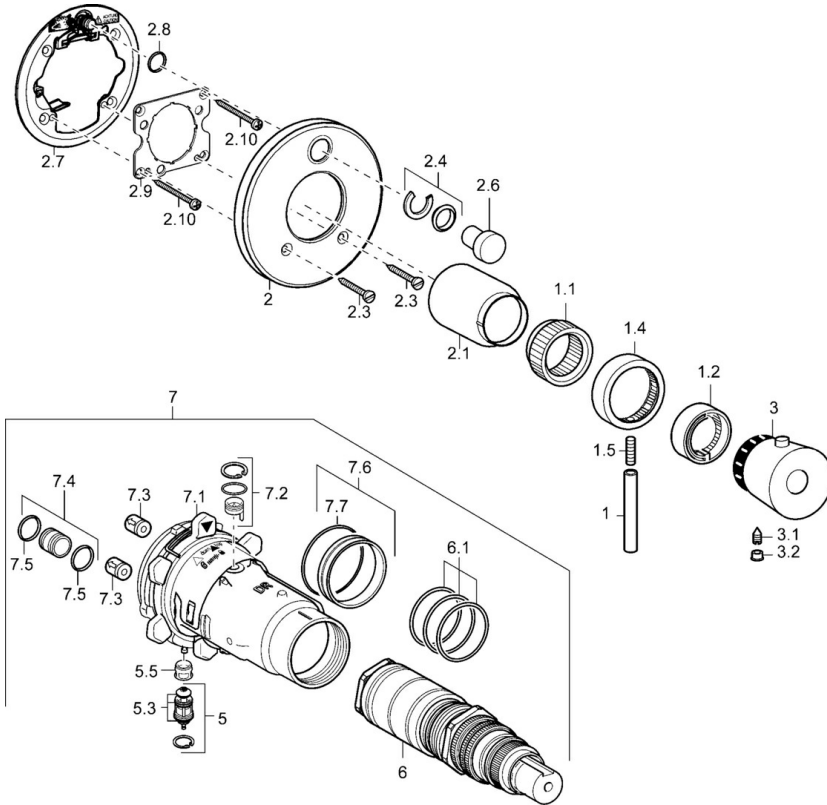

SP46629041

	Name	Code
1	Lever, 80 mm	59912128
1.1	Adapter	59912894
1.2	Temperature adjustment limiter	59912893
1.4	Flow control handle	59912130
1.5	Screw, M6x20	59911228
2	Cover flange Discontinued	59912923
2.1	Covering cap Discontinued	59912922
2.3	Screw, M5x25	59912881
2.4	Flow limiting cap	59912924
2.6	Push button Discontinued	59912925
2.7	Fixing part	59912889
2.8	O-ring, d 7.65x1.78	59902337
2.9	Fixing plate	59913034
2.10	Screw, M4.5x80	59912890
3	Temperature control handle Discontinued	59912541
3.1	Screw, M6x9.5	59901609
3.2	Cover plug	59911840
5	Diverter	59912985
5.3	Sealing kit Discontinued	59912997
5.5	Seat	59912229
6	Thermostatic cartridge, 1/2" Varox	59912843
6.1	O-ring, d 26x2	59911081
7	Functional unit Discontinued	59912905
7	Functional unit, H/C reversed Discontinued	59912979
7.1	Blind nut	59912984
7.2	Back-pressure valve	59912990
7.3	Non-return valve	59905714
7.4	Connection nipple, (2014-)	59913885
7.5	O-ring, d 14x2	59912982
7.6	Ring	59912989
7.7	O-ring, 50.52x1.78	59906841
N.I.	Raising kit, 20 mm	59912754
N.I.	Rebound pin	59912005