

EAN: 4057304007453
static.hansa.com/44870082

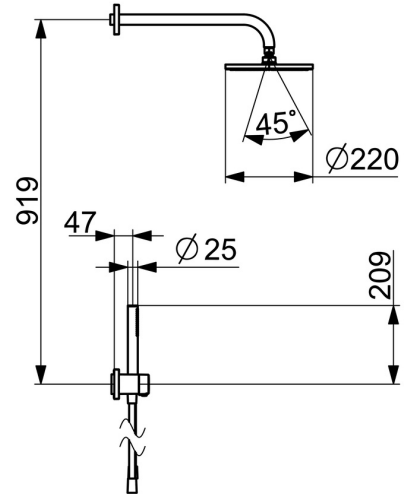

- Dusche
- Thermostat, Fertigmontageset
- Wandmontage für Unterputz-Einbaukörper
- Chrom
- Thermostatkartusche zur Temperaturreglung
- Rosette eckig

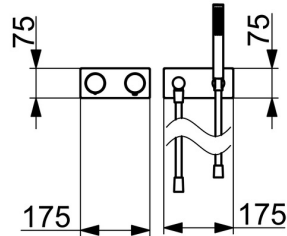
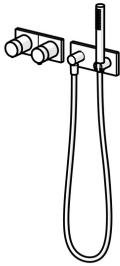
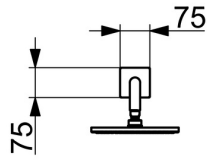

Technische Daten

Durchflusseigenschaften

Durchfluss bei 3 bar	18.0 / 12.0 l/min
Druckverlust bei einem Durchfluss von 0,2 l/s	3 bar

Technische Eigenschaften

Warmwasserversorgung	max. +80°C
Arbeitsdruck	0.5-10 bar
Werkstoff	Messing

Vorschriften

EN Standard	EN 1111
Geräuschklasse	I (ISO 3822)

