

EAN: 4057304007446
static.hansa.com/44870073

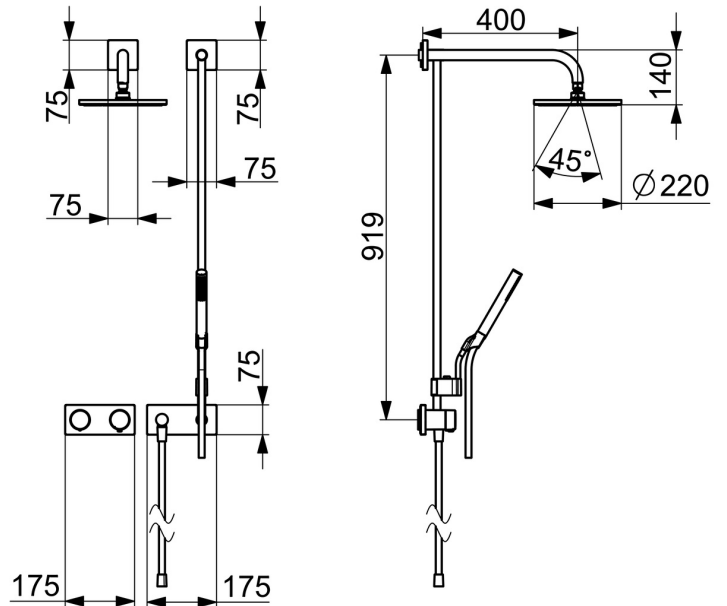

- Douche oplossingen
- Thermostatisch, Afbouwset
- Wandmontage voor inbouwunit
- Chrom
- Thermostatische temperatuurregeling
- Vierkante rozet

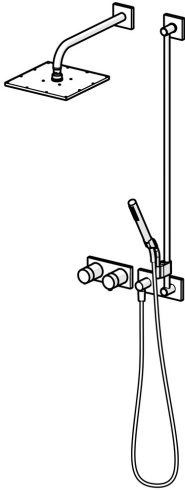

Technische gegevens

Doorstromingseigenschappen

Doorstroomhoeveelheid bij 3 bar	18.0 / 12.0 l/min
Drukverlies bij doorstroomhoeveelheid (0,2 l/s)	3 bar

Technische eigenschappen

Warmwatertoevoer	max. +80°C
Werkdruk	0.5-10 bar
Materiaal	brass

Voorschriften

EN-norm	EN 1111
Geluidsklasse	I (ISO 3822)

