

EAN: 4057304007446
static.hansa.com/44870073

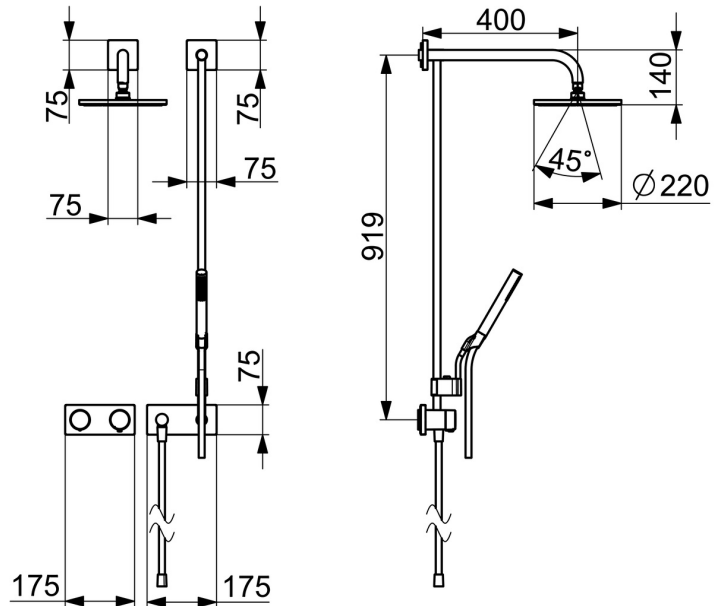

- Solutions de douche
- Thermostatique, Kit de finition
- Montage mural encastré
- Chrome
- Cartouche thermostatique
- Rosace carrée

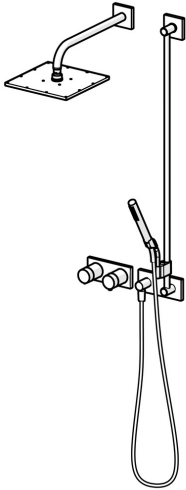

Caractéristiques techniques

Caractéristiques de débit

Débit à 3 bar	18.0 / 12.0 l/min
Perte de charge avec débit (0,2 l/s)	3 bar

Caractéristiques techniques

Alimentation en eau chaude	max. +80°C
Pression de service	0.5-10 bar
Matériau	brass

Règlementations

Norme EN	EN 1111
Classe acoustique	I (ISO 3822)

