

EAN: 4057304007439
static.hansa.com/44870072

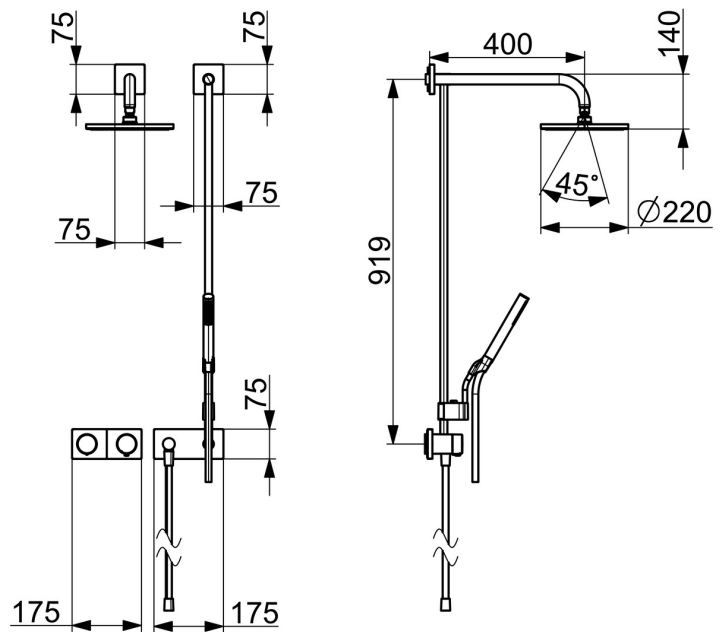

- Soluzioni doccia
- Termostatico, Set esterno
- Montaggio a parete con unità d'incasso
- Cromo
- Regolazione termostatica della temperatura
- Placca quadrata

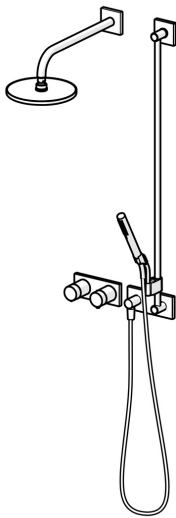

Dati tecnici

Caratteristiche flusso

Portata 3 bar	18.0 / 12.0 l/min
Perdita di pressione con portata (0,2 l/s)	3 bar

Caratteristiche tecniche

Fornitura di acqua calda	max. +80°C
Pressione di esercizio	0.5-10 bar
Materiale	Ottone

Norme

Standard EN	EN 1111
Classe di rumorosità	I (ISO 3822)

