

EAN: 4057304007439
static.hansa.com/44870072

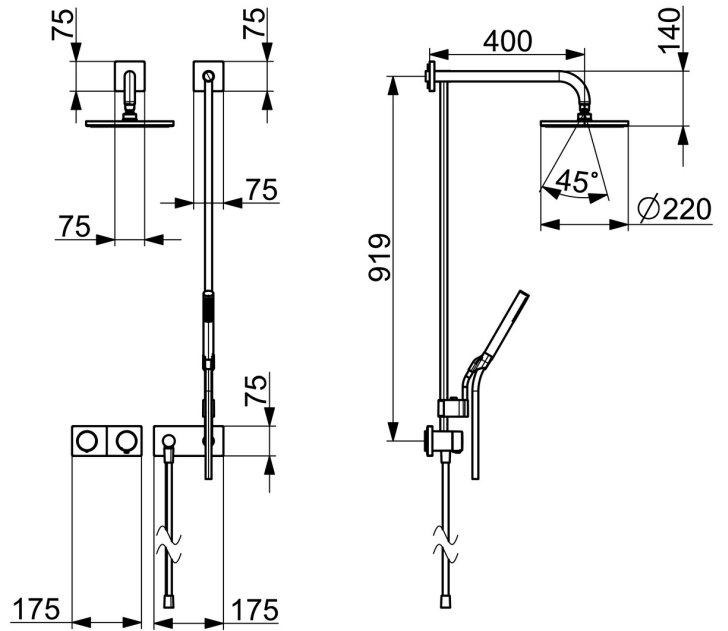

- Shower solutions
- Thermostatic, Trim Kit
- Concealed wall mounting
- Chrome
- Thermostatic cartridge for automatic temperature control
- Square rosette

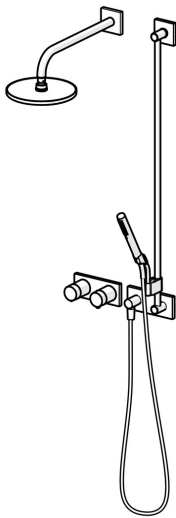

Technical data

Flow properties

Flow-rate at 3 bar	18.0 / 12.0 l/min
Pressure loss with flow (0.2 l/s)	3 bar

Technical properties

Hot water supply	max. +80°C
Working pressure	0.5-10 bar
Material	Brass

Regulations

EN standard	EN 1111
Noise class	I (ISO 3822)

