

EAN: 4015474238787
static.hansa.com/44130100

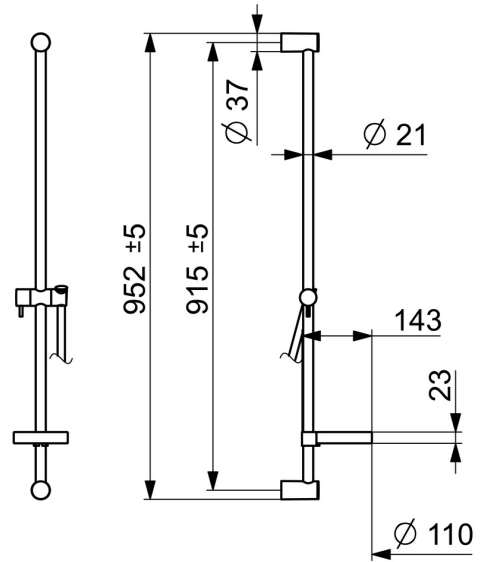

- Shower solutions
- Accessories
- Wall mounted
- Chrome
- Shower hose (1750 mm), Adjustable shower rail bracket, Soap dish
- Flexible length / can be shortened

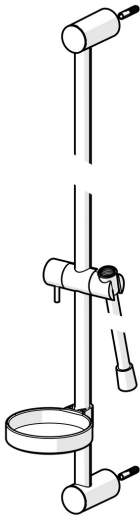

Technical data

Technical properties

Connection size	G1/2
Length / Height	915 mm

Regulations

EN standard	EN 1113
-------------	---------

Approvals and Declarations

Declaration of conformity	DoC
---------------------------	-----

Spare parts

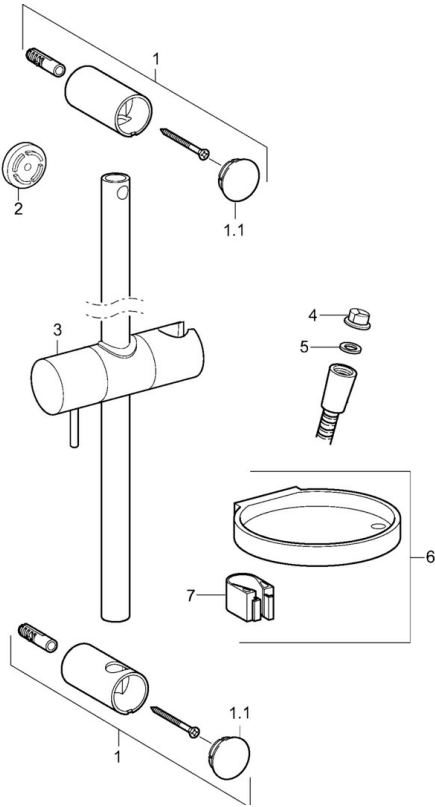

SP44150110

	Name	Code
01	Wall bracket	59913743
01.1	Covering cap	59913744
02	Spacer sleeve, 5 mm	59913742
03	Slide for shower rail	59913755
04	Strainer	59906859
05	Gasket ring, d 21x12x2	59912304
06	Soap tray	59913745
07	Holder	59913983