

EAN: 4015474101722
static.hansa.com/43260900

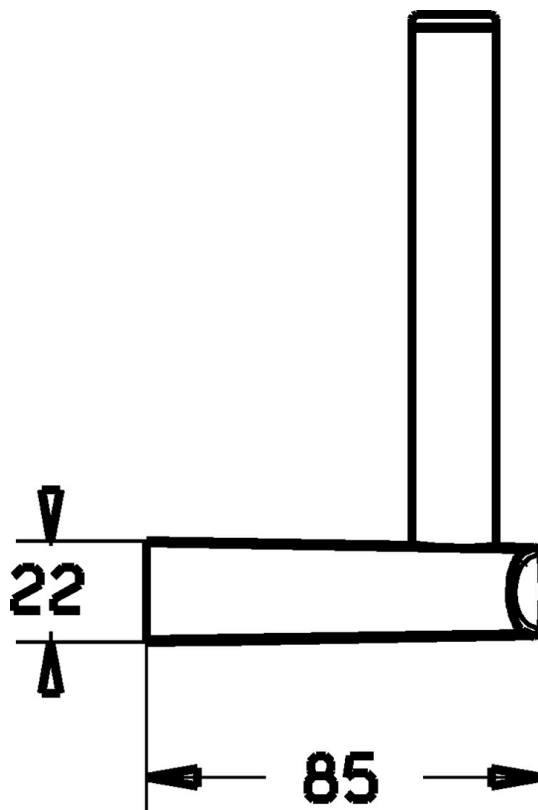

- Salle de bain
- Equipement auxiliaire
- Montage mural
- Chrome



Caractéristiques techniques

Pièces de rechange

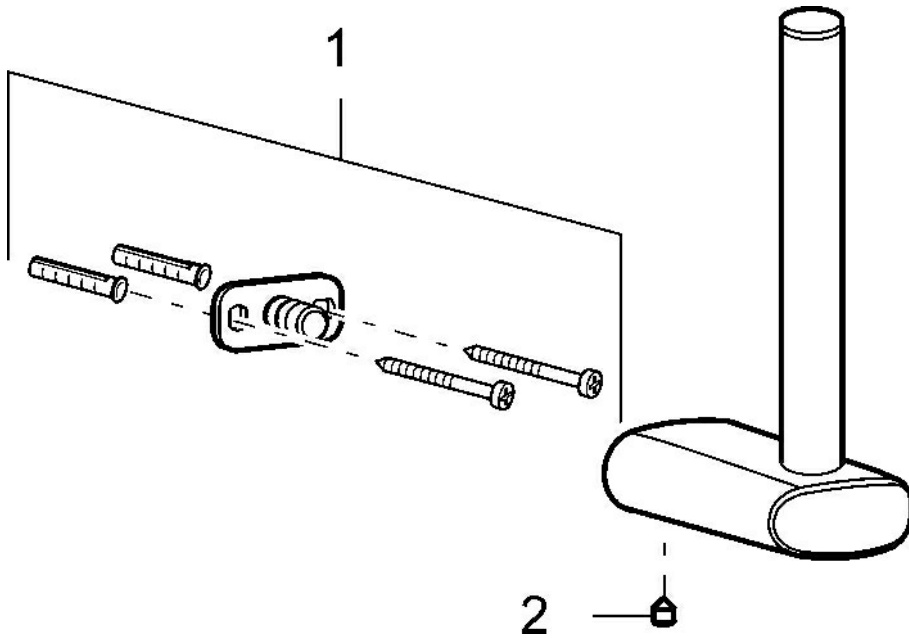

SP43260900

	Nom	Code
1	Ensemble de fixation Arrêté	59912081
2	Vis, M5x6, SW2.5	59912617