

EAN: 4015474142213
static.hansa.com/41802120

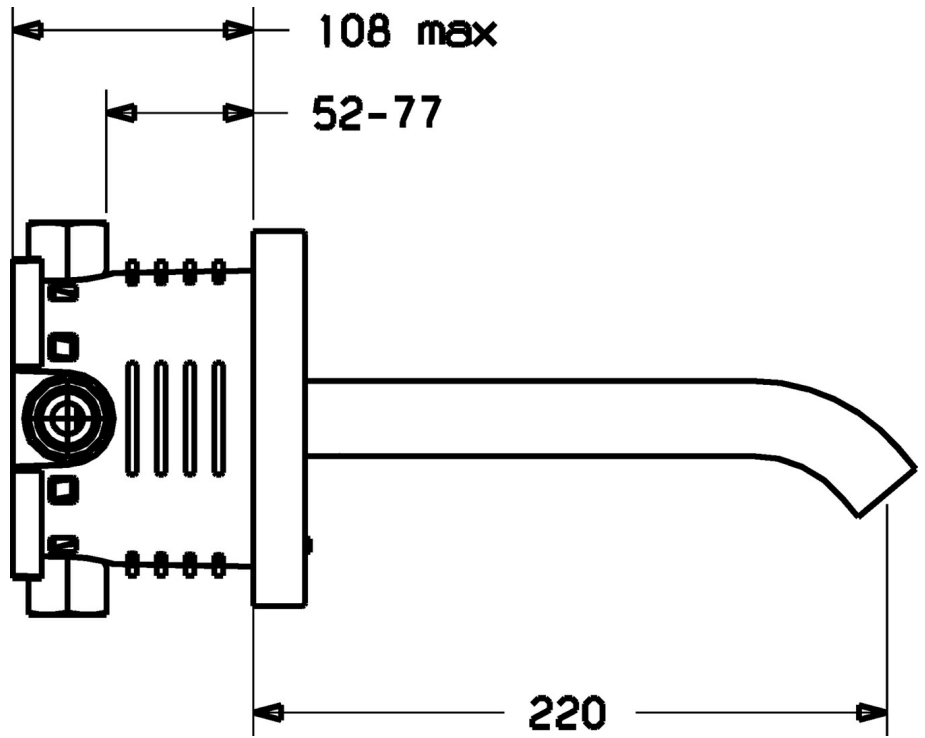

- Washbasin
- Battery-operated
- Concealed wall mounting
- Chrome
- Hidden aerator
- Litter filter(s), Non-return valve(s)
- Low battery indicator, Infrared sensor, Solenoid valve
- One inlet for cold or premixed water
- Software settings adjustable via buttons
- B-Lock mounting system

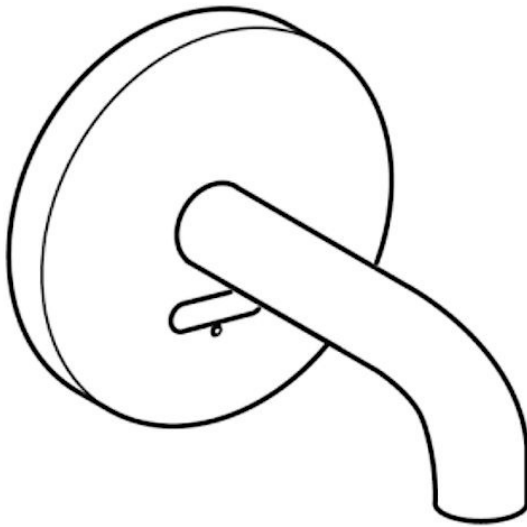

Technical data

Flow properties

Flow-rate at 3 bar **6.0 l/min**

Technical properties

Hot water supply **max. +70°C**
 Working pressure **1-10 bar**
 Projection **220 mm**
 Backflow prevention (EN1717) **EB**
 Material **Brass**

Electronic properties

Battery **Lithium DL223 6 V**

Regulations

EN standard **EN 15091**

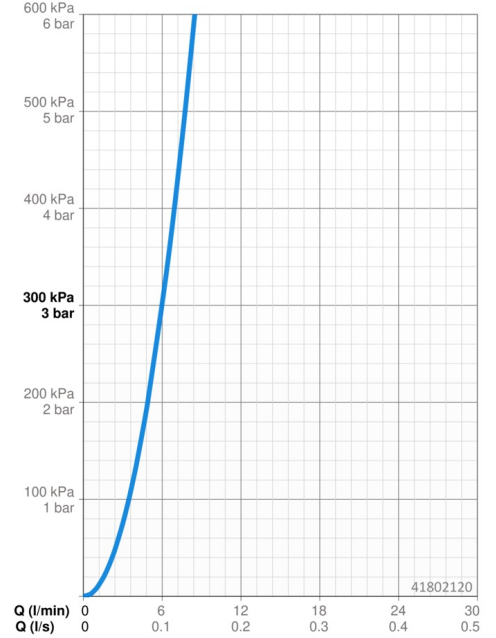

Spare parts

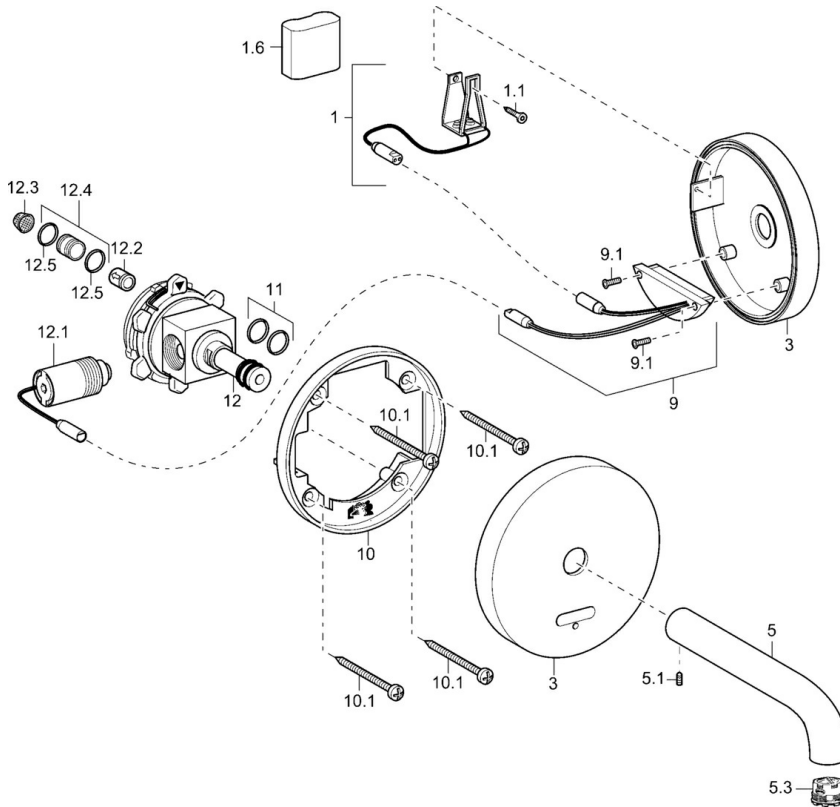

SP41802100

	Name	Code
1	Battery holder	59913143
1.6	Lithium battery, DL223A / CR-P2	59912443
3	Cover plate, d 130 mm Discontinued	59913145
5	Spout, L=120	59913147
5	Spout, L=220 Discontinued	59913149
5	Spout, L=170 Discontinued	59913148
5.1	Screw, M5x6, SW2.5	59912617
5.3	Aerator, M21.5x1	59913128
9	Electronics package, (4180)	59914770
10	Fixing part	59913152
10.1	Screw, M4.5x80	59912890
11	O-ring, d 14.5x2/13x1.9	59913153
12	Support piece, 16x1.5 SW14	59913154
12.1	Solenoid valve	59912240
12.2	Non-return valve	59905714
12.3	Litter filter	59911684
12.4	Connection nipple, (2014-)	59913885
12.5	O-ring, d 14x2	59912982
N.I.	Aerator, M21.5x1	59913598
N.I.	Key for aerator, M21.5x1	59913133
N.I.	Functional unit, AQUIS 397.339.00	59914722