

EAN: 4015474053922
static.hansa.com/08385292

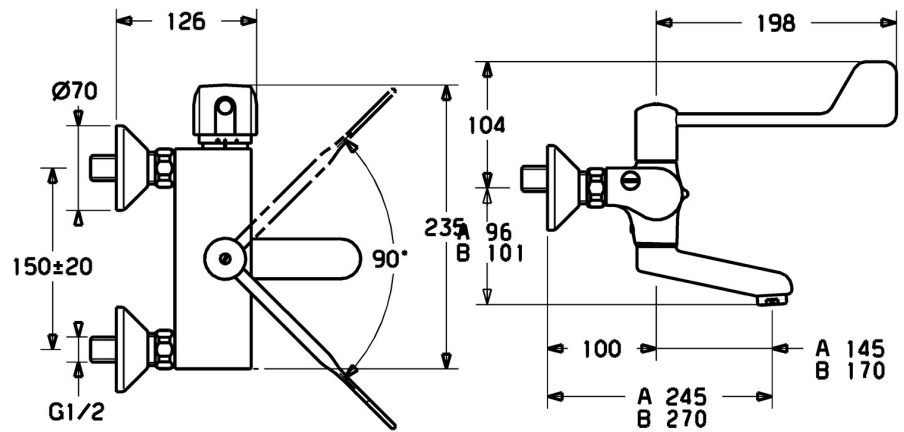

- Health & Care
- Thermostatic
- Wall mounted
- Chrome
- Swivel spout, Self-draining model, Lockable in the middle position, Casted construction
- Standard aerator
- Temperature control handle, Flow control handle, Long shape, Safety feature for water temperature
- Limitation option for maximum temperature and flow-rate, Adjustable hot water stop (included, retrofittable), Safety stop against scalding at 38°C
- Ceramic head part for flow control, Thermostatic cartridge for automatic temperature control, Non-return valve(s), Litter filter(s)
- Eccentric coupling(s), with integrated shut-off valve(s)
- Inner body made of DZR brass, Waterways without nickel coating, Thermal disinfection without cartridge readjustment
- Retrofit safety lock 59912005, can be ordered optionally.

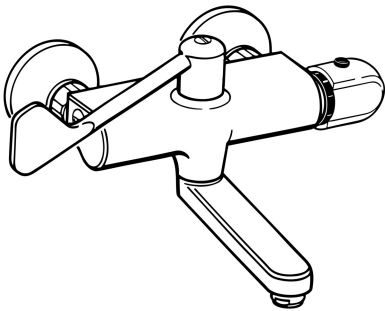

Technical data

Flow properties

Flow-rate at 3 bar **12.0 l/min**

Technical properties

DN-size (nominal dimension) **DN15**
 Hot water supply **max. +80°C**
 Working pressure **1-10 bar**
 Connection size **G1/2**
 Installation width **150 ± 20 mm**
 Projection **270 mm**
 Backflow prevention (EN1717) **AA**
 Material **Brass**

Regulations

EN standard **EN 1111**
 Noise class **I (ISO 3822)**

Approvals and Declarations

ABP **PA-IX 10126/IA**
 Declaration of conformity **DoC**

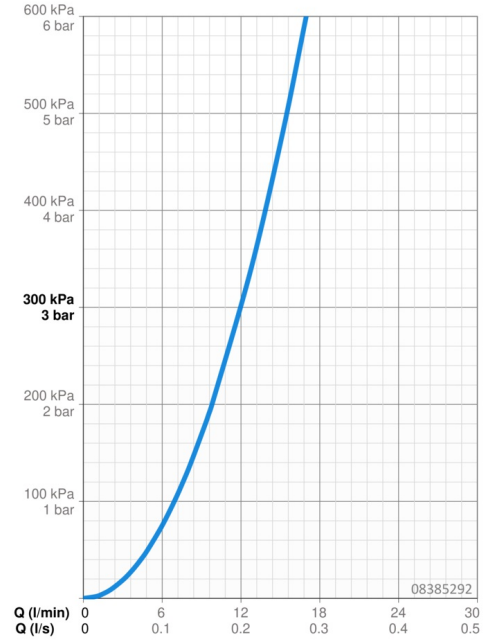

Spare parts

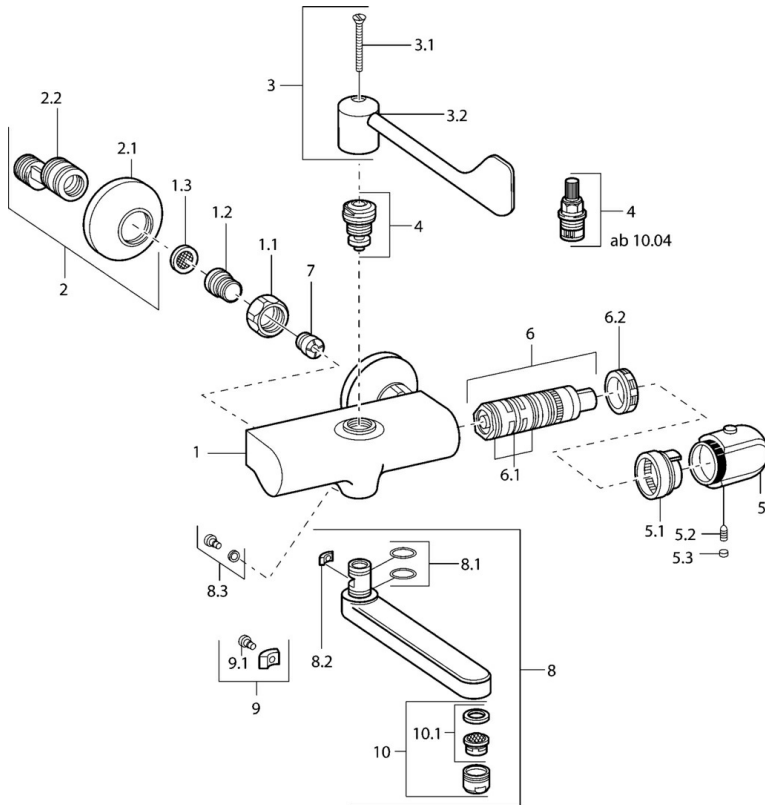

SP08382202

	Name	Code
1.1	Connection nut, G3/4, AF30	59902230
1.2	Nipple	59911075
1.3	Filter sealing, G3/4	59911076
2	Eccentric coupling with stop valves and cover plates, G1/2xG3/4	59902034
2.1	Cover flange	59904796
3	Lever, (2004-)	59912715
3	Lever	59911377
3.1	Screw, M5x40 Discontinued	59911378
3.1	Screw, M4x18 (2004-)	59912716
4	Headpart, G1/2, 90°, (2004-)	59912626
4	Headpart, G1/2, DN 15	59901530
5	Temperature control handle, (2011-), desinfektion	59913869
5	Temperature control handle	59911830
5	Temperature control handle, 38° limited	59911726
5.1	Temperature adjustment limiter	59911660
5.2	Screw, M6x9.5	59901609
5.3	Cover plug	59911840
6	Thermostatic cartridge, H/C reversed	59911527
6	Thermostatic cartridge	59911525
6.1	O-ring, d 26x2	59911081
6.2	Tightening nut, M34x1, SW32	59911082
7	Non-return valve	59905714
8	Spout, L=170	59911183
8	Spout, L=96	59910419
8	Spout, L=235	59910417
8	Spout, L=170 (2019-)	59914766
8	Spout, L=145 (2019-)	59914768
8	Spout, L=145	59911380
8.1	O-ring, d 15x2.5	59910423
8.2	Limiter	59910422
8.3	Fixing screw, M6x12, AF2.5	59904804
8.4	Maintenance set	59912230
9	Limiter	59910421
9.1	Screw, M6x10, 2,5	59911435
10	Aerator, M24x1 A, low pressure	59902692
10	Aerator, M24x1 STD HC A	59902366
10.1	Aerator, M22/24 A	59902081
N.I.	Vacuum breaker, DN15	59911330
N.I.	Emptying valve	59912483
N.I.	Rebound pin	59912005