

EAN: 4057304013782
static.hansa.com/08300201

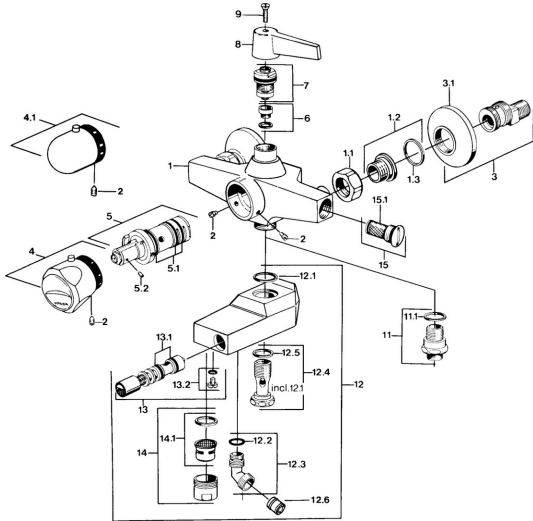

- Shower solutions
- Thermostatic
- Wall mounted
- Chrome
- Temperature control handle
- Non-return valve(s)

Technical data

Technical properties

Hot water supply	max. +80°C
Working pressure	0.5-10 bar
Backflow prevention (EN1717)	EB

Spare parts

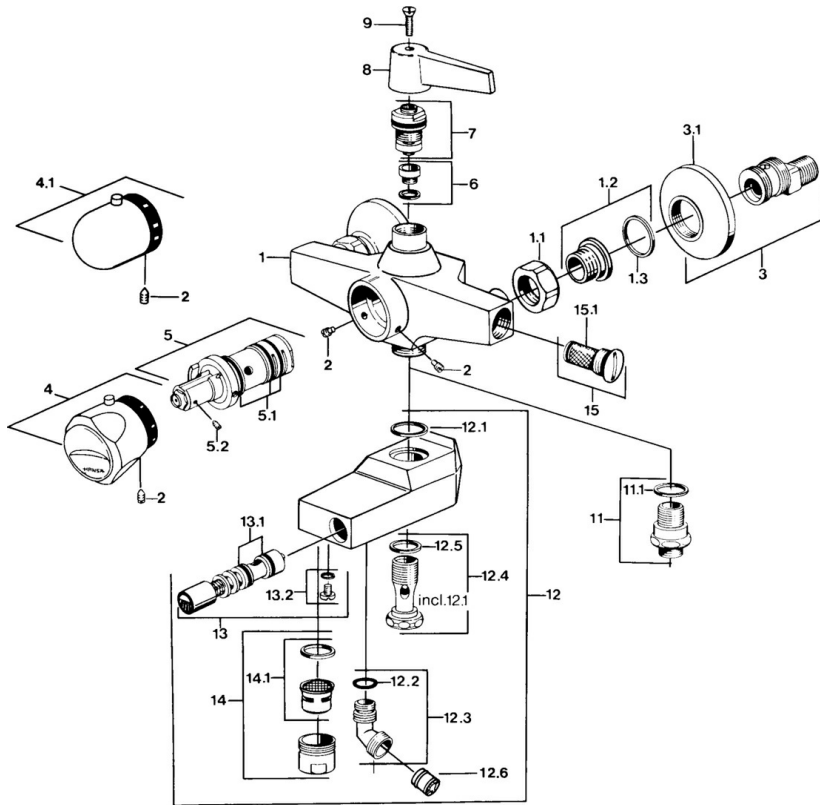

SP08352201

Name	Code
1.1 Connection nut, G3/4, AF30	59902230
1.2 Seat, G1/2, L, WAF10	59904618
1.3 Retaining ring, 23.9x15.2x2	59902689
2 Screw, M6x9.5	59901609
3 Eccentric coupling with stop valves and cover plates, G1/2xG3/4	59902034
3.1 Cover flange	59904796
4 Temperature control handle Discontinued	59906965
4.1 Temperature control handle	59910304
5 Thermostatic cartridge Discontinued	59901608
5.1 O-ring, d 27x2	59901532
5.2 Screw, M4x4	59901027
6 Seat, DN15, R1/2	59904616
7 Headpart, G1/2, DN 15	59901530
12.2 O-ring, 12.37x2.65 Discontinued	59902340
12.5 Gasket, 25x21x1.5 Discontinued	59902318
12.6 Non-return valve	59905714
14 Aerator, M28x1 C	59902088
14.1 Aerator, M28x1 C Discontinued	59902089
15 Non-return valve	59901610
15.1 Strainer Discontinued	59901638
N.I. Thermostatic cartridge Discontinued	59901668