

EAN: 4015474551695  
[static.hansa.com/0374210086](http://static.hansa.com/0374210086)

- Bathtub & Shower
- Single-lever
- Wall mounted
- Single operating lever/handle, Hot/Cold symbols
- Limitation option for maximum temperature and flow-rate, Adjustable hot water stop (included, retrofittable)
- $\varnothing$  48 mm ceramic eco cartridge for flow and temperature control, Non-return valve(s)
- Without operation lever

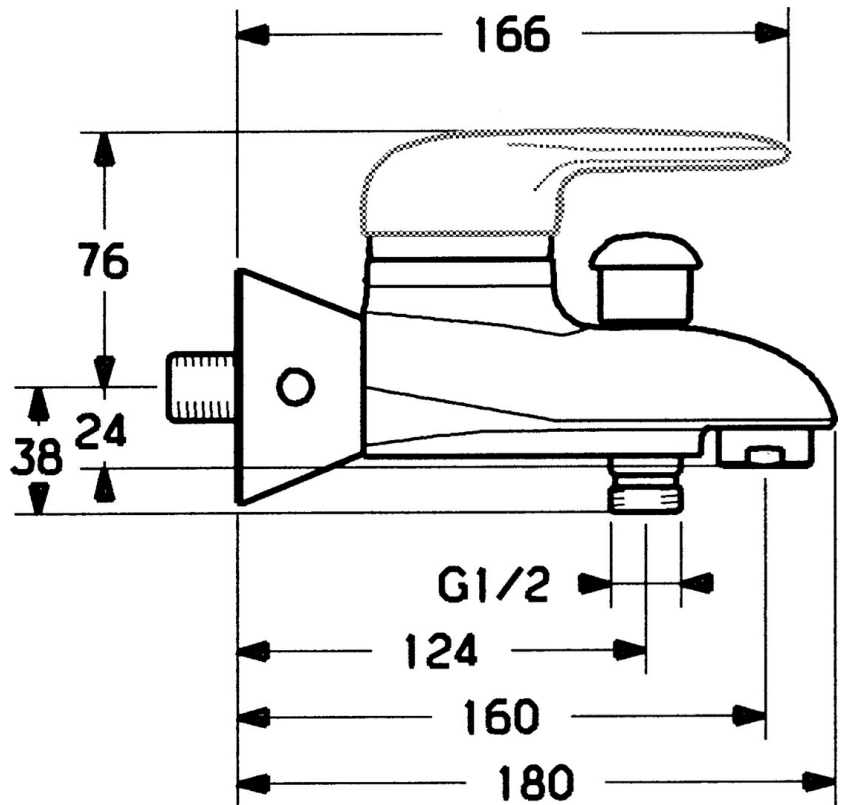
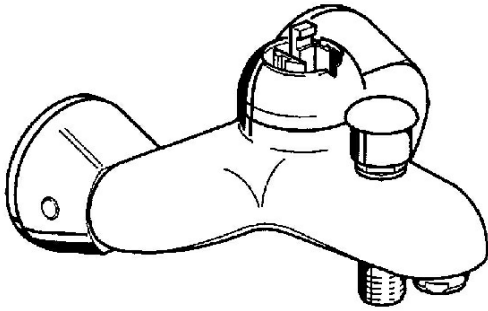

## Technical data

### Technical properties

Hot water supply	max. +80°C
Working pressure	0.5-10 bar
Backflow prevention (EN1717)	EB

### Regulations

EN standard	EN 817
-------------	--------

## Spare parts

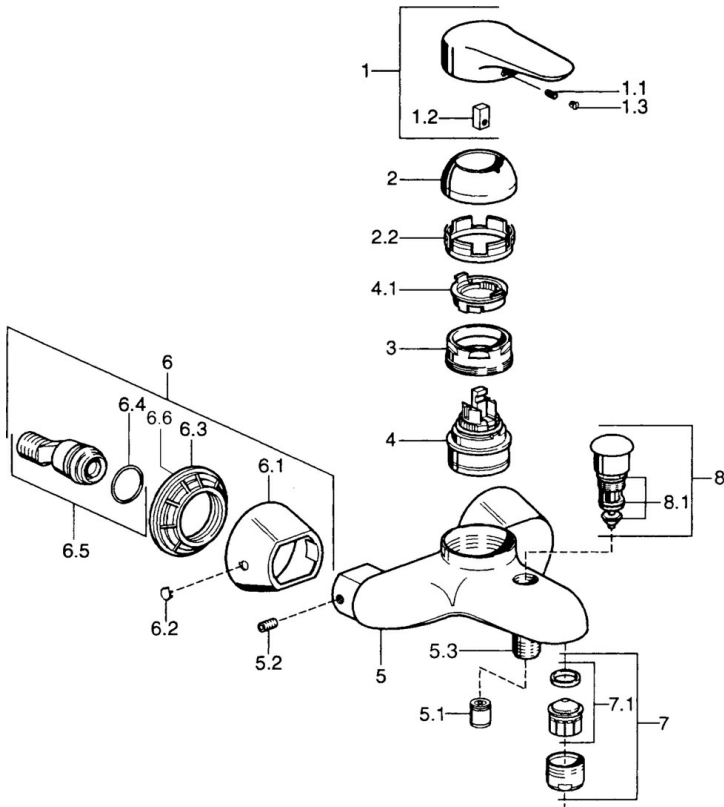

### SP03742102

	Name	Code
1	Lever, 99 mm, red/blue Discontinued	59913769
1	Lever, L=99 mm, (-2011)	59913768
1	Lever, L=138 mm Discontinued	59913770
1.1	Screw, M5x8, SW2.5	59904755
1.2	Bushing	59904778
1.3	Plug, hot/cold	59906705
2	Covering cap Chrome/Satin Discontinued	59906564
2	Covering cap	59906563
2.2	Fixing sleeve	59906695
3	Eye screw, M50x1, SW45	59904775
4	Cartridge, 4.8 eco	59904601
4.1	Hot water limiter	59904759
5.1	Non-return valve	59905714
5.2	Screw, M8x8	59906104
5.3	Thread nipple, G1/2xM18x1	59911384
5.6	Vacuum breaker, DN15	59911330
6.1	Cover flange Discontinued	59911473
6.2	Plug Discontinued	59911480
6.3	Adapter Discontinued	59911486
6.4	O-ring, 25.07x2.62	59911479
6.5	Connector, G1/2	59911491
7	Aerator, M28x1 C White Discontinued	59905683
7	Aerator, M28x1 C	59902088
7	Aerator, M28x1 Edelmessing Discontinued	59906687
7.1	Aerator, M28x1 C Discontinued	59902089
8	Diverter Discontinued	59911492
8.1	Sealing kit	59904791

