

EAN: 4015474606623
static.hansa.com/02370100

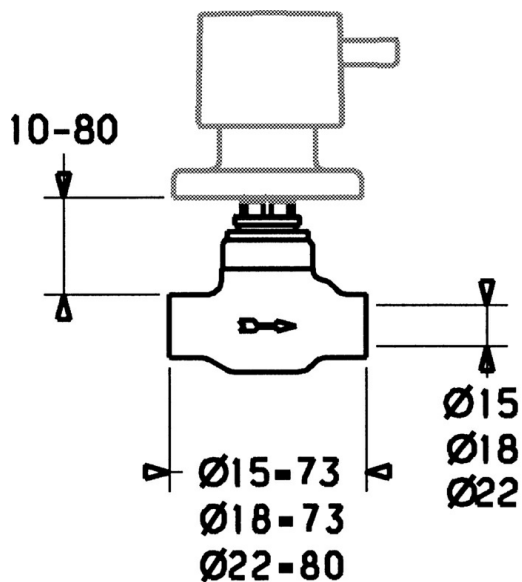

- Náhradné diely
- Chróm



Technické údaje

Technické vlastnosti

Dodávka teplej vody	max. +80°C
Pracovný tlak	0.5-10 bar

Náhradné diely

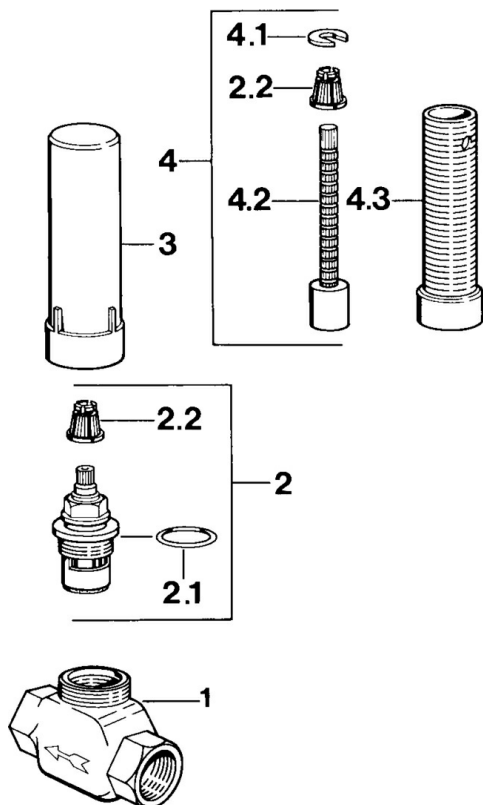

SP02250100

	Názov	Kód
2	Sedlo, G3/4, 180°	59910383
2.1	O-kružok, 23x1.78	59910693
2.2	Adaptér Biela	59910235
3	Antivandal krytka termostatu	59910667
4	Nadstavný segment, 80 mm	59910424
4.1	Kružok	59910694
4.2	Vnútorné vreteno	59910379
4.3	Závitové puzdro, M24x1.5	59910100