

EAN: 4015474023925
static.hansa.com/01536206

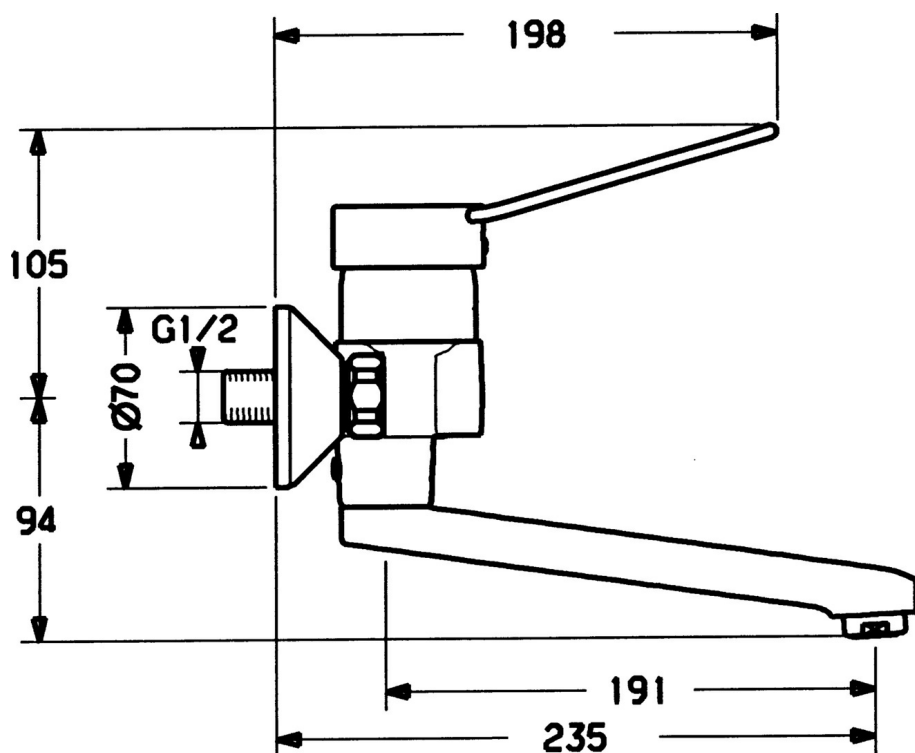

- Health & Care
- Monocomando
- Montaggio a parete
- Cromo
- Leva/Manopola monocomando, Leva con simbolo F+C
- Raccordi a S eccentrici



Dati tecnici

Caratteristiche tecniche

Fornitura di acqua calda	max. +80°C
Pressione di esercizio	0.5-10 bar
Materiale	Ottone

Norme

Standard EN	EN 817
-------------	--------

