

EAN: 4015474023932
static.hansa.com/01536106

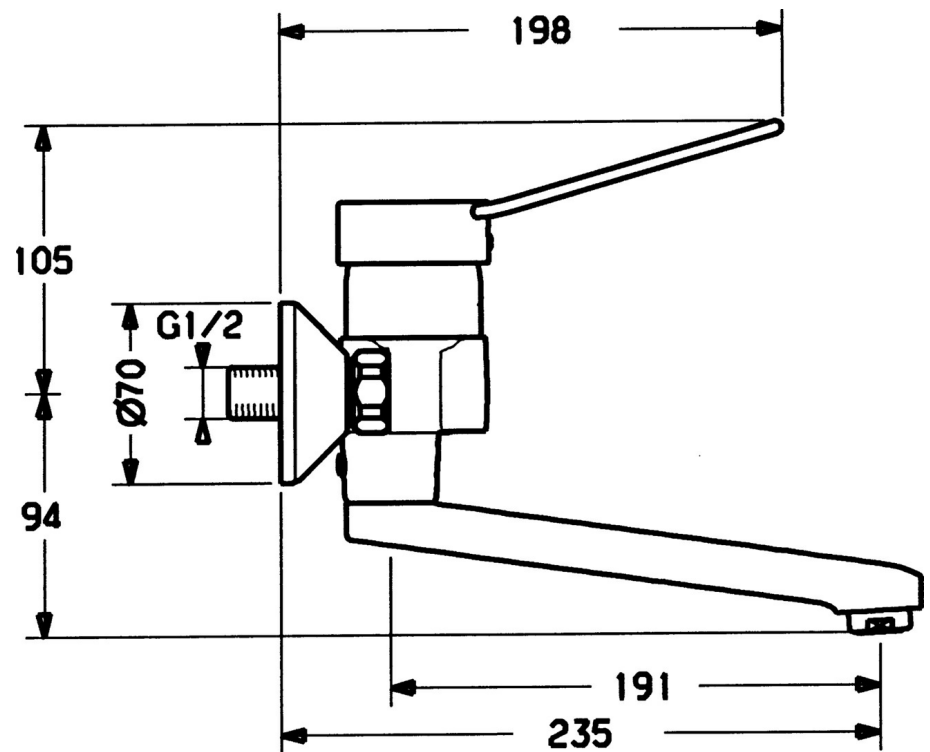

- Health & Care
- Single-lever
- Wall mounted
- Chrome
- Single operating lever/handle, Hot/Cold symbols
- Eccentric coupling(s)



Technical data

Technical properties

Hot water supply	max. +80°C
Working pressure	0.5-10 bar
Material	Brass

Regulations

EN standard	EN 817
-------------	--------

Spare parts

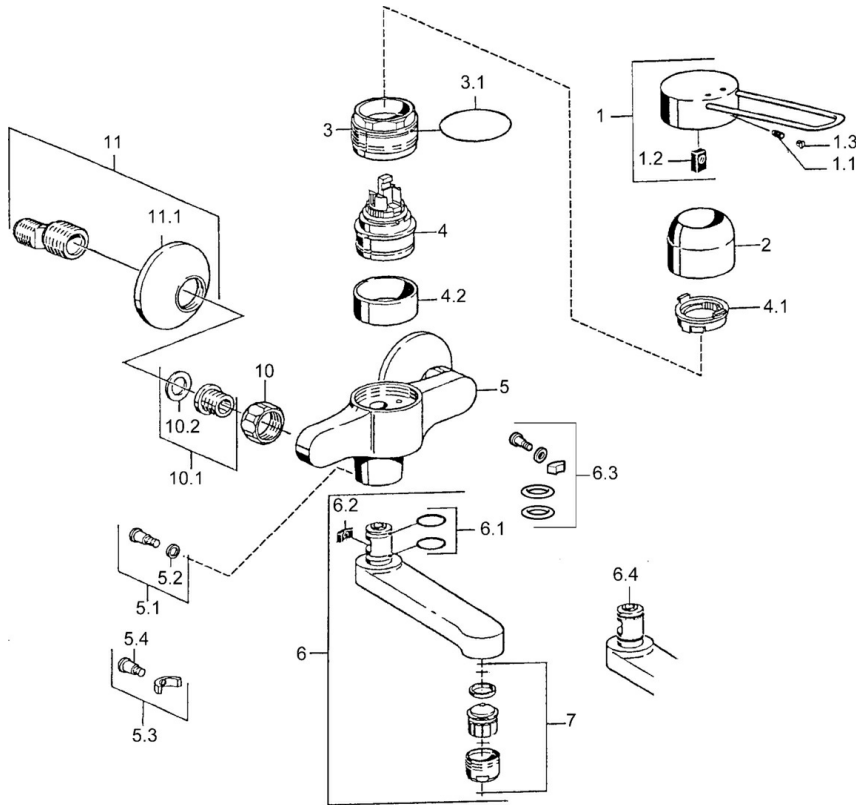

SP01526106

	Name	Code
1	Lever Discontinued	599015806
1.1	Screw, M5x8, SW2.5	59904755
1.2	Bushing	59904778
2	Covering cap	59911160
3	Tightening nut, M52x1, AF45	59911161
3.1	O-ring, d 39x2.5 Discontinued	59911162
4	Cartridge, 4.8 eco	59904601
4.1	Hot water limiter	59904759
4.2	Spacer sleeve Discontinued	59905871
5.1	Fixing screw, M6x12, AF2.5	59904804
5.3	Limiter	59910421
5.4	Screw, M6x10, 2,5	59911435
6	Spout, L=116 Discontinued	59912048
6	Spout, L=191 Discontinued	59912049
7	Aerator, M24x1, 7 l/min (-2013) Discontinued	59912004
10	Connection nut, G3/4, AF30	59902230
10.1	Seat, G1/2, L, WAF10	59904618
11	Eccentric, G3/4xG1/2	59904793
11.1	Cover flange	59904796